

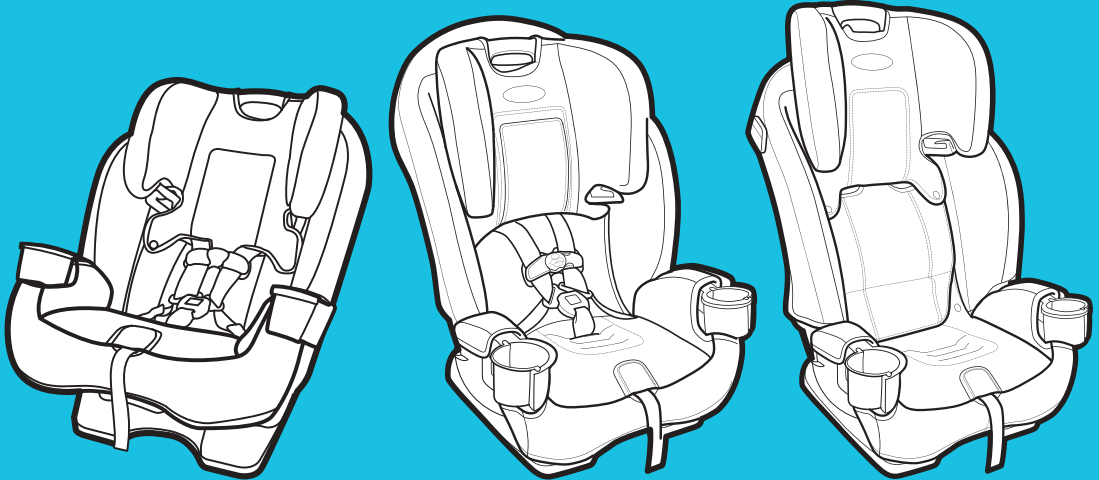

SLIMFIT®

3 IN 1 CAR SEAT

Read This Instruction Manual



Do not install or use this child restraint until you read and understand the instructions in this manual.

FAILURE TO PROPERLY USE THIS CHILD RESTRAINT INCREASES THE RISK OF SERIOUS INJURY OR DEATH IN A SUDDEN STOP OR CRASH.

1 Important

Pages 4-13

- 1-A Quick Guide to Your Manual**
- 1-B Welcome to the Graco Family!**
- 1-C Right Mode of Use**
- 1-D Before You Begin**
 - Register This Child Restraint
 - If You Need Help
 - Certification
 - Car Seat's Useful Life
 - Vehicle Seat Protection
 - Warm Weather Use
- 1-E Safety Warnings**

2 Features

Pages 14-16

3 Rear-Facing

Pages 17-23

- 3-A Rear-Facing Use**
- 3-B Install Rear-Facing With Lower Anchor Attachment**
- 3-C Install Rear-Facing With Vehicle Seat Belt**

4 Forward-Facing

Pages 24-30

- 4-A Forward-Facing Use**
- 4-B Install Forward-Facing With LATCH**
- 4-C Install Forward-Facing With Vehicle Seat Belt**

5 Booster Use

Pages 31-36

- 5-A Booster Use**
- 5-B Install Highback Booster**

6 Securing Child

Pages 37-42

- 6-A Securing Child 5-point Harness**
- 6-B Securing Child Highback Booster**

7 Moving Lower Anchor Attachment

Pages 43-45

8 Accessories

Pages 46-47

9 Vehicle Information

Pages 48-54

- 9-A How to Uninstall Lower Anchor Connectors and Tether**
- 9-B Choosing Vehicle Seat Location**
- 9-C Unsafe Vehicle Seat Locations**
- 9-D Vehicle Seat Belts**

10 Care & Cleaning

Pages 55-57

- 10-A Cleaning Seat Pad**
- 10-B Cleaning Crotch Buckle**
- 10-C Cleaning Harness, Lower Anchor and Tether**



1 Important

1-A Quick Guide to Your Manual

This car seat is for children: *Rear-Facing: 5-40 lb (2.3-18 kg)*
Forward-Facing: 22-65 lb (10-30 kg), 49” (125 cm) or less.
Booster: 40-100 lb (18.1-45 kg), 43-57” (110.1-145 cm), and at least 4 years old.

Get to Know Your Car Seat

Review section 2-A to see all of the features of this infant car seat.

What Seating Location Should I Use?

The best seating location for this infant car seat is one that:

- Is recommended by your vehicle owner’s manual, and
- Results in a secure installation of this car seat.

Some vehicles have specific requirements for where the car seat can be installed, so be sure to check your vehicle owner’s manual for available seating positions, if any. For example, sometimes the center rear seat has a lap belt only vehicle seat belt, which cannot be used when this car seat is in Booster mode.

Review section 9-A, 9-B of this manual AND your vehicle owner’s manual.

!WARNING!



NEVER place this child restraint rear-facing in a vehicle seating location that has an active front air bag.

In the event there is no back seat, review your vehicle owner’s manual to see how to use your infant child restraint.

According to accident statistics, children are safer when properly restrained in the rear seating positions than in the front seating positions. The center of the back seat can be the safest during a possible side impact. The center of the back seat can be the safest during a possible side impact.



Which Installation Method Should I Use?

This car seat can be installed in your vehicle using either the vehicle seat belt OR the LATCH system OR the lower anchor system. All are equally safe to use. **INSTALL USING ONLY ONE METHOD.**

Vehicle Seat Belt: Review section 9 and your vehicle owner’s manual to learn how to install your car seat with the vehicle seat belts.

LATCH or Lower Anchor Attachment: The LATCH system or Lower Anchor Attachment allows you to securely attach your safety seat in your car without using the vehicle seat belt and possibly to get a better fit. All 2003 and newer model year vehicles are required to have a LATCH system, although some manufacturers began including LATCH earlier. Some vehicle owner manuals use the term ISOFIX to identify the LATCH system.

What is LATCH?

LATCH consists of lower anchors and a tether anchor, which are built-in to your vehicle, and lower anchor attachments and tether that is built-in to your car seat. Lower anchor attachments are used **INSTEAD** of the vehicle’s seat belt to secure the child seat to the vehicle. The tether is used **IN ADDITION** to the lower anchor attachments **OR** the vehicle’s seat belt to secure a forward-facing car seat to the vehicle.

Review your vehicle’s owner manual for exact location and use.

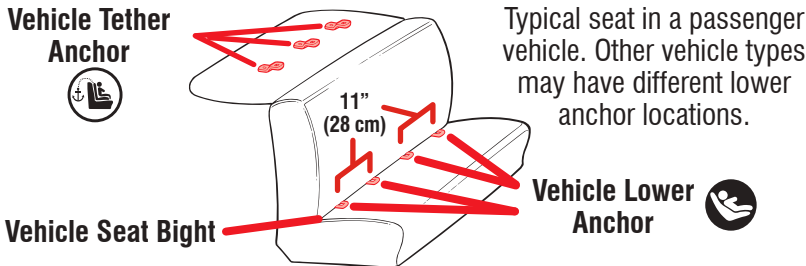

When Installing Rear-Facing or Forward-Facing

Lower Anchor Attachment

The lower anchor attachment consists of two lower anchors, which are built-in to your vehicle, and lower anchor connectors that are built-in your car seat. Review section 3-B, 4-B of this manual AND your vehicle owner’s manual before installing.

Lower anchor attachment can ONLY be used if the vehicle lower anchor spacing is 11 inches (28 cm) from the center of one lower anchor to the center of the other lower anchor.

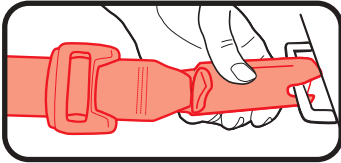
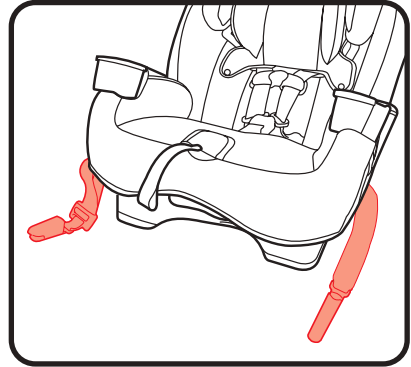

Vehicle Seat Belt

There are two types of vehicle seat belts that can be used. Lap/Shoulder Seat Belt or Lap Only Seat Belt.

Review section 3-C, 4-C and 9 of this manual AND your vehicle owner’s manual before installing.

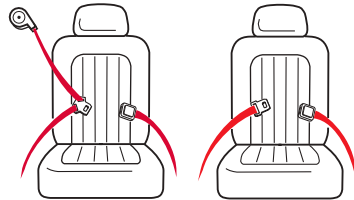

When Installing As a Booster

Vehicle Seat Belt

Only use the Lap/Shoulder seat belt configuration.

Review section 5-B of this manual AND your vehicle owner’s manual.

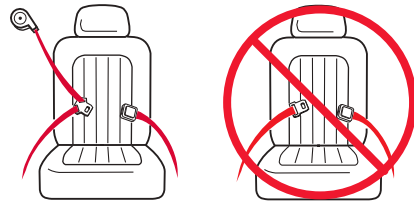

Does Your Car Seat Fit Your Child Correctly?

To make sure your child is secured properly, review section 3,4 and 5 to understand all of the actions you need to take to properly adjust the car seat to fit your child.

i 1 Important

For Rear-Facing and Forward-Facing, You Need to Adjust:

Harness Height, Rear-Facing (A)

Harness straps at or just below the child's shoulders and top of head **must** be 1" (2.5 cm) below the headrest adjustment lever (B). Review section 6.

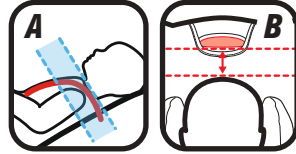

Harness Height, Forward-Facing (C)

Harness straps at or just above the child's shoulders and top of child's ears below top of headrest (D). Review section 6.

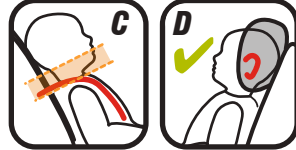

Buckle Position (E)

The correct slot is the one that is closest to your child without being underneath them. Review section 6.

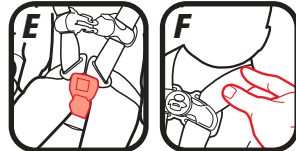

Harness Tightness (F)

If your fingers slide off the harness straps without pinching the straps, it is tight enough. Review section 6.

For Booster, You Need to Adjust:

Use Lap/Shoulder Belt Only

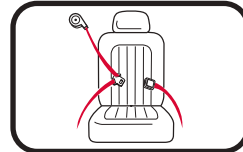

Position Lap Belt

Lap belt must go behind armrest and lie low across your child's hips and thighs.

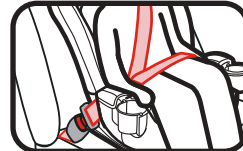

Position Shoulder Belt

Shoulder belt lies across shoulder between neck and edge of shoulder.

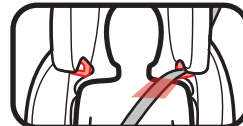

Did You Do Everything Correctly?

Rear-Facing

Car Seat Does Not Move More than 1” (2.5 cm) at the Belt Path (A)

Review section 3

Level Indicator’s Bubble in the Blue Zone (B)

Review section 3

Harness Straps at or Just Below the Child’s Shoulders (C)

Review section 6.

Chest Clip Even With Armpits (D)

Review section 6

Cannot Pinch Harness Straps at the Shoulder (E)

Review section 6

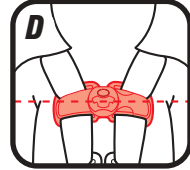
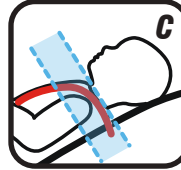
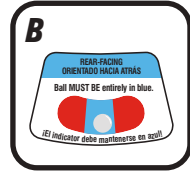
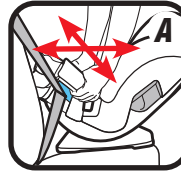

Forward-Facing

Use the tether strap when using forward-facing (A)

When used properly, the tether helps reduce injury in a sudden stop or crash. Review section 4

Car Seat Does Not Move More than 1” (2.5 cm) at the Belt Path (B)

Review section 4

Harness Straps at or Just Above Child’s Shoulders (C)

Review section 6

Chest Clip Even With Armpits (D)

Review section 6

Cannot Pinch Harness Straps at the Shoulder (E)

Review section 6

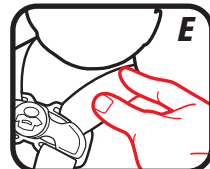
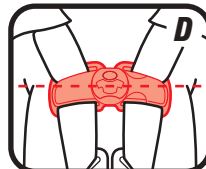
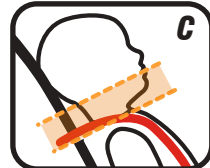
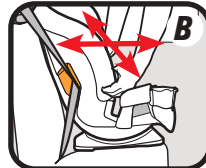
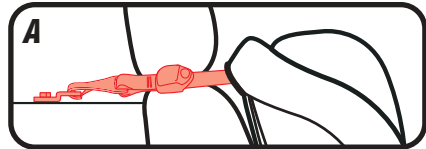

Booster

Never Use Lap Belt Only

Review section 6

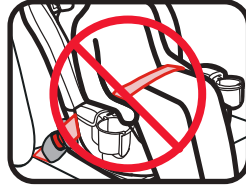

Lap Belt Behind Armrest and Lies Low Across Hips and Thighs

Review section 6

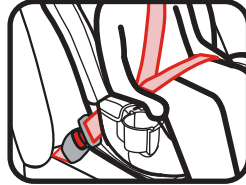

Shoulder Belt Lies On the Shoulder, Between the Neck and Edge of Shoulders

Review section 6

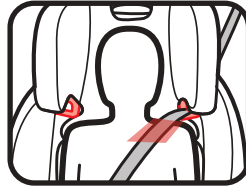

i 1 Important

1-B Welcome to the Graco Family!

Your child's safety depends on you. No car seat can guarantee protection from injury in every situation, but proper use helps reduce the risk of serious injury or death.

Even if this car seat seems easy to figure out on your own, you must follow the detailed instructions in this instruction manual to ensure the steps below are performed correctly.



1 Important

1-C Right Mode of Use

5 lb (2.3 kg)	22 lb (10 kg)	40 lb (18 kg)	65 lb (30 kg)	100 lb (45 kg)
------------------	------------------	------------------	------------------	-------------------

Rear-Facing with 5-Point Harness

Must be 49" (125 cm) or less: 5-22 lb (2.3-10 kg) and less than 1 year old **MUST** be rear-facing. 22-40 lb (10-18 kg) **SHOULD** be rear-facing*.

Forward-Facing with 5-Point Harness

Must be 49" (125 cm) or less: 22-40 lb (10-18 kg) and can sit upright unassisted **CAN** be forward-facing. 40-65 lb (18-30 kg) **SHOULD** be forward-facing*.

Booster Mode with Vehicle Lap/Shoulder Seat Belt

Must be 43-57" (110.1-145 cm) and 4+ years old: 40-65 lb (18.1-30 kg) **CAN** be in booster mode. Over 65 lb (30 kg) **MUST** be in booster mode*.

* Check your state laws and the AAP/NHTSA recommendations. See page 12-13.

Note: Preterm or low birth weight infants may be at special risk in a vehicle or aircraft. According to the AAP, these infants may suffer breathing issues if improperly reclined in a car seat. When rear-facing, use the corrected age for preemies. Graco advises that you have your physician or hospital staff evaluate your infant and recommend the proper car seat or car bed before you and your infant leave the hospital.

1-D Before You Begin

Register This Child Restraint

Please fill out the prepaid registration postcard attached to the harness and mail it in today **or register online at www.gracobaby.com/carseatregistration.**

Child restraints could be recalled for safety reasons. You must register this restraint to be reached in a recall. Send your name, address, and the restraint's model number and manufacturing date to:

Graco Children's Products, Inc.
 Attn: Customer Service
 P.O. Box 169, Elverson, PA 19520-9901
 or call 1-800-345-4109
or register online at
www.gracobaby.com/carseatregistration

For recall information, call the U.S. Government's Vehicle Safety Hotline at 1-888-327-4236 (TTY: 1-800-424-9153), or go to <http://www.NHTSA.gov>.

For future reference or if you change addresses, record the model name, model number, date of manufacture, and purchase date of this car seat below. You can find this information either on the registration card if you still have it or on the date label located on the back of the car seat.

Model Name _____

Model Number _____

Date of Manufacture _____

Date of Purchase _____

If You Need Help

In the U.S.A, please contact our Customer Service Department with any questions you may have concerning parts, use, or maintenance. When you contact us, please have your product's model number and date of manufacture ready so that we may help you efficiently. These numbers can be found on a sticker on the back side of your car seat.

For additional resources or to get your car seat checked by a child passenger safety technician, please visit the following web sites:

www.nhtsa.gov • www.seatcheck.org • www.safekids.org • www.cpsc.gov

Certification

This child restraint meets or exceeds all applicable requirements of Federal Motor Vehicle Safety Standard 213 for use in motor vehicles.



This child restraint is certified for use in aircraft only when used with the internal harness system. Use only forward-facing aircraft seats. For rear-facing installation, see section 3-C and 9-D Lap Belt Installation. For forward-facing installation, see section 4-C and 9-D Lap Belt Installation, but do not use top tether. Contact the airline for their specific policies.



This child restraint is NOT certified for use in aircraft when used as a booster seat because aircrafts do not have shoulder belts.

Contact the airline for their specific policies.

Car Seat's Useful Life

STOP using this car seat and throw it away 10 years after the date of manufacture. Look for date of manufacture label on back of the car seat.

Graco Children's Products Inc. advises against loaning or passing along a car seat unless you know the complete history of the product. We also advise against purchasing a car seat second hand.

Vehicle Seat Protection

Protect vehicle seat. Use a car seat mat, towel, or thin blanket under and behind car seat.

Warm Weather Use

Car seat parts can get very hot in the sun or warm weather. **To avoid burns, always check before putting child in car seat.**

1-E Safety Warnings

No car seat can guarantee protection from injury in every situation, but proper use helps reduce the risk of serious injury or death.

READ THIS MANUAL CAREFULLY.

⚠ WARNING!

Failure to follow these instructions and child restraint's labels can result in child striking the vehicle's interior during a sudden stop or crash.



! NEVER PLACE THIS CHILD RESTRAINT REAR-FACING IN A VEHICLE SEATING LOCATION THAT HAS AN ACTIVE FRONT AIR BAG.

If an air bag inflates, it can hit the child and car seat with great force and cause serious injury or death to your child.

! Review your vehicle owner's manual for more information about air bags and car seat use.

! If your vehicle does not have a back seat, review your vehicle owner's manual.

! Children are safer riding rear-facing and should ride rear-facing as long as possible, until they reach the maximum rear-facing height or weight rating for their car seat. Then children should ride forward-facing, using the built-in harness system for as long as possible until they reach the maximum forward-facing weight or height for their car seat. At that point, children should ride in a belt-positioning booster seat. A booster is no longer needed once the vehicle seat belt fits properly, typically when they reach 4 feet 9 inches (145 cm) tall and are between ages 8-12. Be sure to check your local and state laws, as well as AAP and NHTSA recommendations, for car seat usage.*

- ! Choose the correct mode of use for the car seat depending on your child's size. Infants less than 22 lb (10 kg) MUST use this car seat rear-facing.**
- ! Select a suitable location for the car seat in your vehicle.**
- ! Secure car seat with a vehicle seat belt or lower anchor attachment that is properly routed as shown in this manual.**
- ! Vehicle seat belt system MUST hold car seat securely. Not all vehicle seat belts can be used with a car seat.**
- ! If vehicle seat belt does not hold car seat securely, read "Vehicle Seat Belts" section 9-D and your vehicle owner's manual.**
- ! Always secure car seat with lower anchor attachment or a vehicle seat belt, even when unoccupied. In a crash, an unsecured car seat can injure passengers.**
- ! If car seat is in a crash, it must be replaced. DO NOT use it again! A crash can cause unseen damage and using it again could result in serious injury or death.**
- ! DO NOT use car seat if it is damaged or missing parts.**
- ! DO NOT use accessories or parts other than those provided by Graco except for a thin towel or mat to protect your vehicle seat or a rolled towels or pool noodles to help get your car seat level. Their use could alter the performance of the car seat.**
- ! DO NOT remove LATCH system from car seat. If using vehicle seat belt to secure car seat, lower anchor connectors must be stored.**
- ! Never leave child unattended, even when sleeping. Child may become tangled in harness straps and suffocate or strangle.**
- ! Rear-facing car seat must be properly leveled:**
 - Too reclined can result in injury or ejection.
 - Too upright can result in breathing difficulties.
- ! Never attach two lower anchor connectors to one vehicle lower anchor point unless specifically allowed by the vehicle manufacturer.**
- ! Do not use both the vehicle seat belt and lower anchor attachment at the same time when using the car seat with the 5-point harness.**



*Graco Supports the American Academy of Pediatrics and National Highway Traffic Safety Administration's Car Seat Guidelines. Visit www.gracobaby.com/en-US/safety for information on car seat usage recommendations.

2-A Features

2 Features

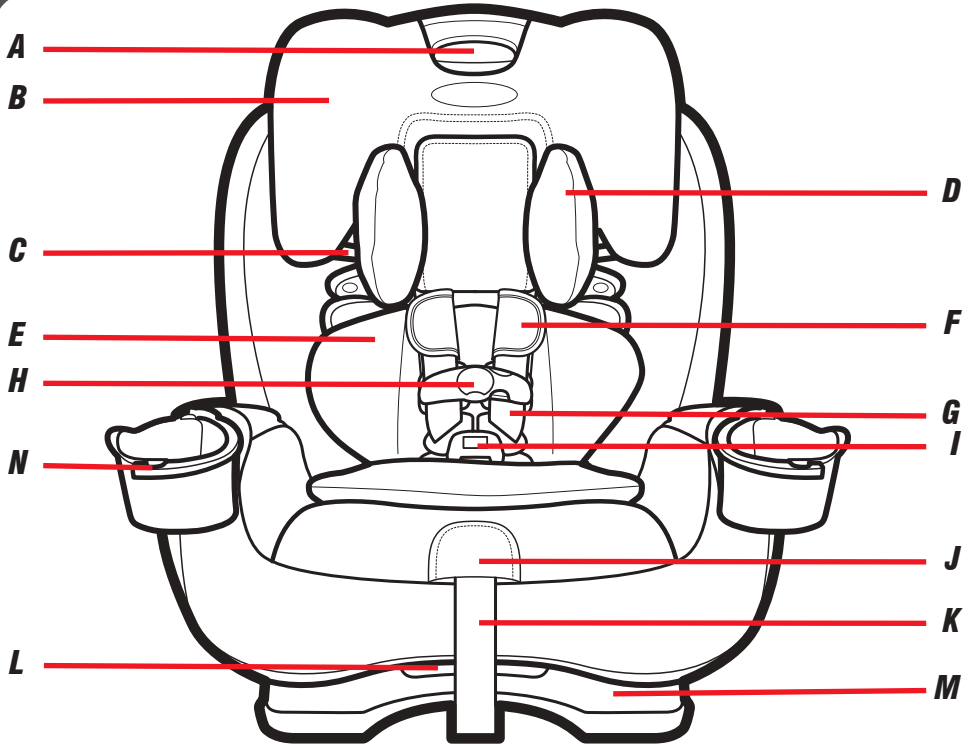

A Headrest/Harness Adjustment Handle

B Headrest

C Booster Shoulder Belt Guide

D Headrest Pillow

E Body Pillow

F Harness Covers

G Harness Straps

H Chest Clip

I Buckle

J Harness Release Lever
(under flap)

K Harness Adjustment Strap

L Recline Handle

M Seat Base

N Cup Holder

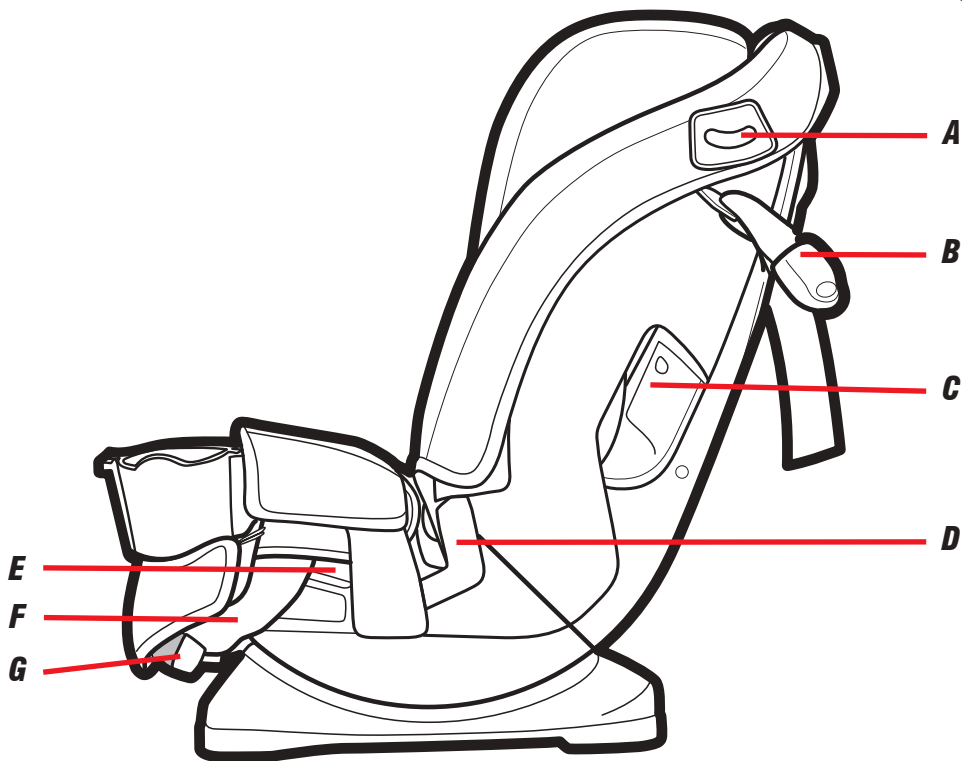

- A Rear-Facing Level Indicator**
- B Tether**
- C Forward-Facing Belt Path**
- D Booster Lap Belt Path**
- E Rear-Facing Belt Path**
- F Lower Anchor Strap**
- G Lower Anchor Storage**

2 Features

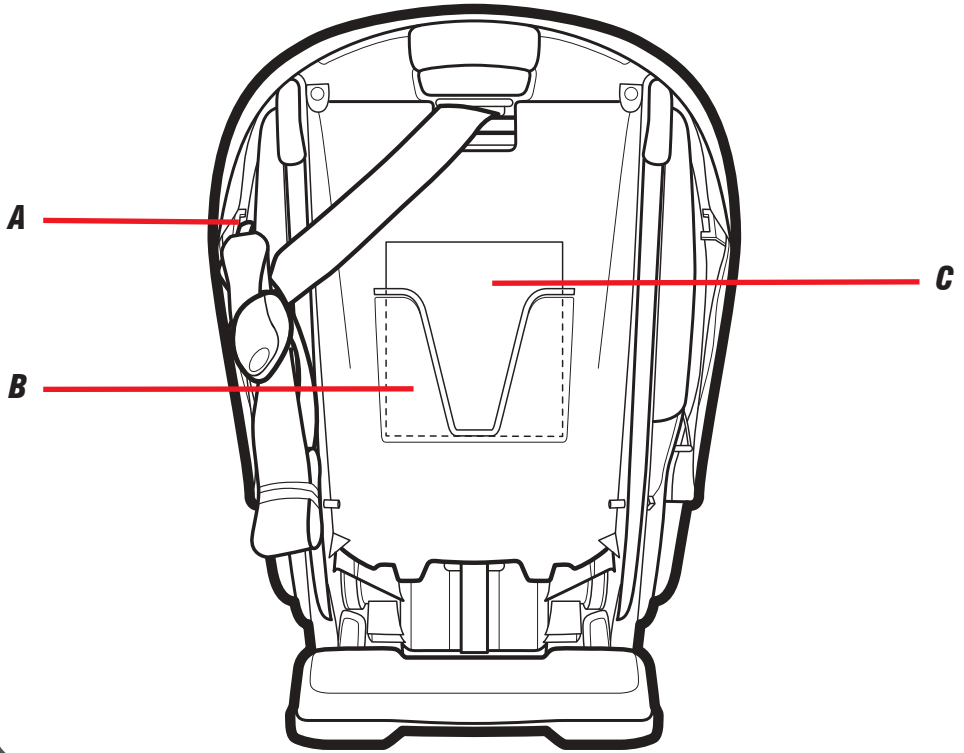

- A Tether Storage***
- B Instruction Manual Storage***
- C Instruction Manual***

3-A Rear-Facing Use

Rear-Facing: 5-40 lb (2.3-18 kg) and whose head is at least 1" (2.5 cm) below the headrest adjustment handle

- Car seat must be rear-facing in the vehicle back seat.
- Make sure lower anchor strap or vehicle seat belt is routed through the rear-facing belt path, marked with a blue label.
- Install this car seat tightly in your vehicle. Car seat **should not move** at the rear-facing belt path more than 1" (2.5 cm) from side to side and front to back.
- Check the rear-facing level indicator to make sure the ball is completely in the blue zone. Vehicle **MUST** be on level ground.
- Harness straps must be **at or just below** the top of child's shoulders and chest clip must be at **armpit level**.
- Infants who weigh less than 22 lb (10 kg) **MUST be rear-facing**.
- Children are safer riding rear-facing and should ride rear-facing as long as possible, until they reach the maximum rear-facing height or weight rating for their car seat. Then children should ride forward-facing, using the built-in harness system for as long as possible until they reach the maximum forward-facing weight or height for their car seat. Be sure to check your local and state laws, as well as AAP and NHTSA recommendations, for car seat usage.

⚠ WARNING!



NEVER place this child restraint rear-facing in a vehicle seating location that has an active front air bag.

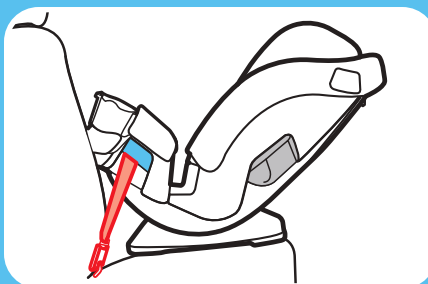

Lower Anchor Attachment

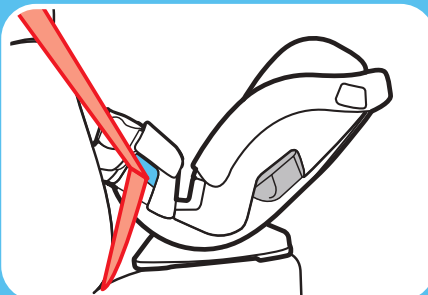

Vehicle Lap/Shoulder Seat Belt

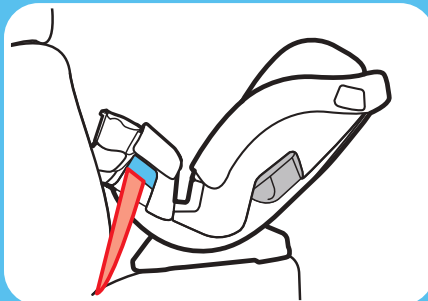

Vehicle Lap Only Seat Belt



3 Rear Facing

3-B Install Rear-Facing With Lower Anchor Attachment

Review your vehicle's owner manual for lower anchor location and use.

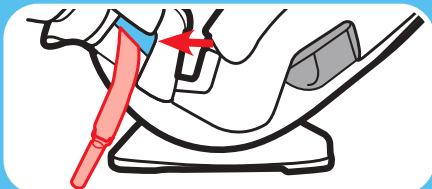

1. **Make Sure Lower Anchor Strap is in the Rear-Facing Belt Path Marked With a Blue Label**

If it is not, see section 7-A to move lower anchor attachment.

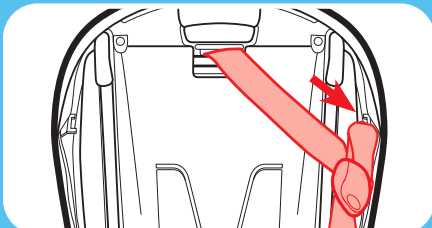

2. **Store Tether Strap**

Attach tether hook to the plastic bar on either side of the car seat.

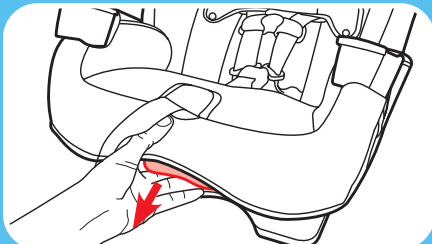

3. **Recline the Car Seat**

Place the car seat in recline position 1 or 2.

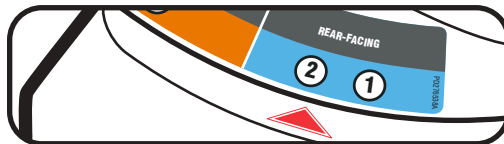

4. **Remove Lower Anchor Connectors from Storage Location**

Push in on the red buttons on the lower anchor connectors and remove from storage position.

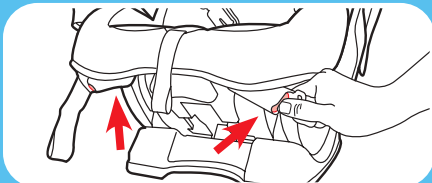

5. **Extend the Lower Anchor Strap**

For easier installation, extend the lower anchor strap to its maximum length by pressing the grey button and pulling on the strap.

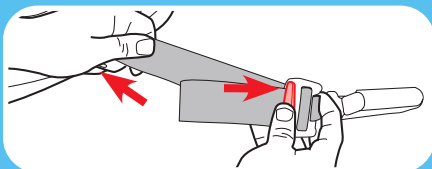

3 Rear Facing

6. Place Car Seat Rear-Facing in Back Seat of the Vehicle

Place rear-facing in vehicle seat and center the car seat between the lower anchors. The base should sit as flat as possible on the vehicle seat.

Make sure base is a minimum of 80% on the vehicle seat.

7. Check the Level Indicator

Vehicle **MUST** be on level ground. **Ball must be completely in the blue zone.** Readjust the incline if needed. Or if needed, rolled towels may be placed under the car seat at the vehicle seat crease, until the ball is completely in the blue zone.

8. Attach Lower Anchor Connectors to Vehicle's Lower Anchors

Lower anchor strap should lie flat and not be twisted. **Lower anchor attachment can ONLY be used if the vehicle lower anchor spacing is 11 inches (28 cm) from the center of one lower anchor to the center of the other lower anchor.**

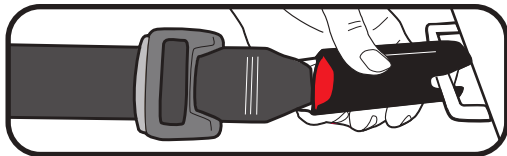

9. Tighten the Lower Anchor Strap

Press down firmly in the center of the car seat while tightening the lower anchor strap.

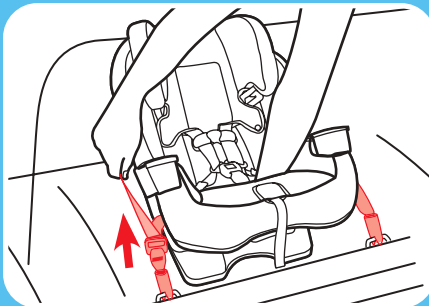
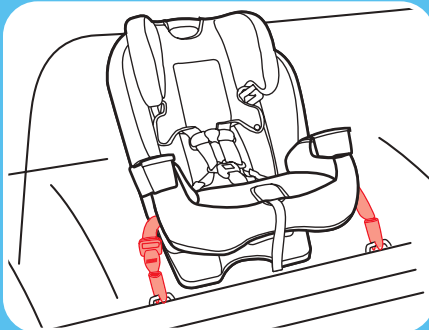
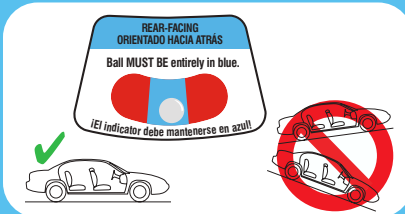
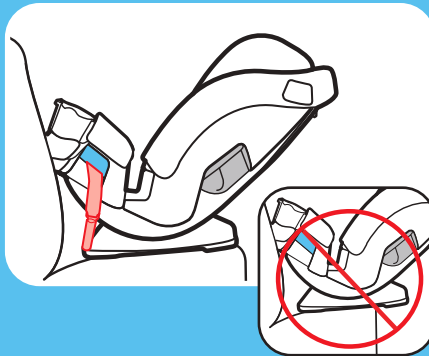

3 Rear Facing

3 Rear Facing

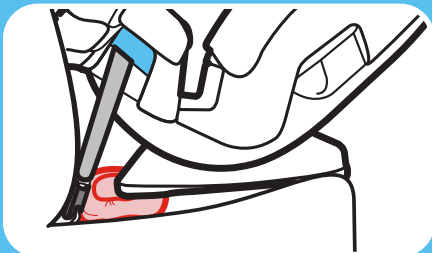
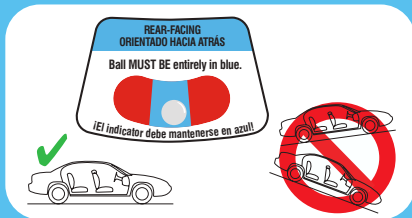
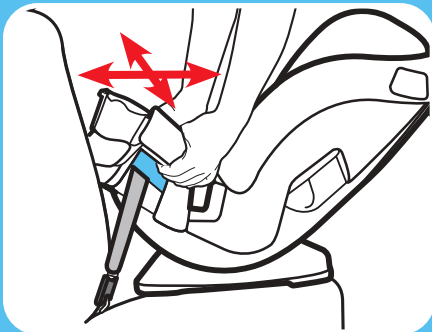
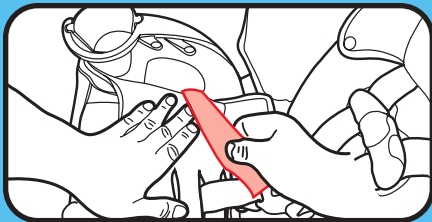

Note: For easier tightening, you may need to pull the tail of the lower anchor strap through the belt path as shown.

10. Test For Tightness

Grab the sides of the seat where the lower anchor strap is and slide the car seat side-to-side and front-to-back.

If the seat moves less than 1" (2.5 cm), it is tight enough.

11. Check the Level Indicator

Vehicle **MUST** be on level ground. **Ball must be completely in the blue zone.**

Readjust the incline if needed. Or if needed, rolled towels may be placed under the car seat at the vehicle seat crease, until the ball is completely in the blue zone.

See section 6-A to secure your child.

Recheck the level indicator with child in seat.

3-C Install Rear-Facing With Vehicle Seat Belt

1. Recline the Car Seat

Place the car seat in recline position 1 or 2.

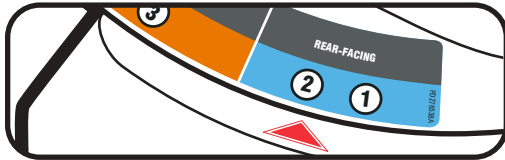

2. Store Tether and Lower Anchor Straps

Attach tether hook and lower anchor connectors to the plastic bars as shown. Remove the slack from both straps.

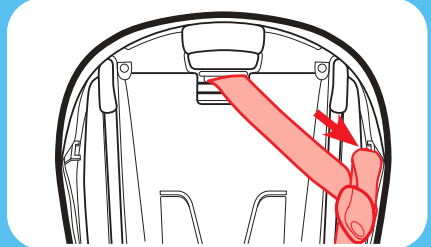
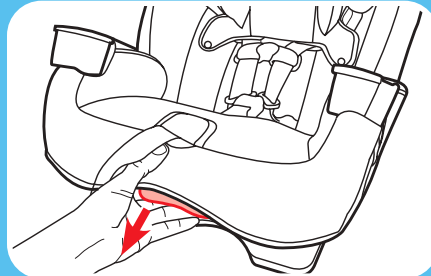
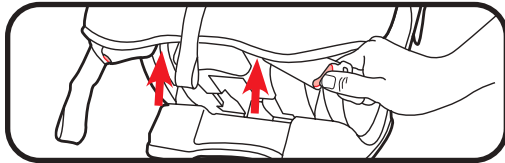

3. Place Car Seat Rear-Facing in Back Seat of the Vehicle

Place the base flat on the vehicle seat. Push it back until the front of the car seat touches the vehicle seat back.

Make sure base is a minimum of 80% on the vehicle seat.

4. Check the Level Indicator

Vehicle **MUST** be on level ground. **Ball must be completely in the blue zone.** Readjust the incline if needed. Or if needed, rolled towels may be placed under the car seat at the vehicle seat crease, until the ball is completely in the blue zone.

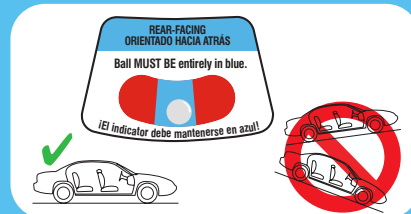
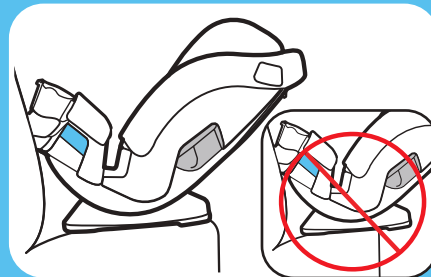

3 Rear Facing

Review your vehicle's owner manual for vehicle seat belt use

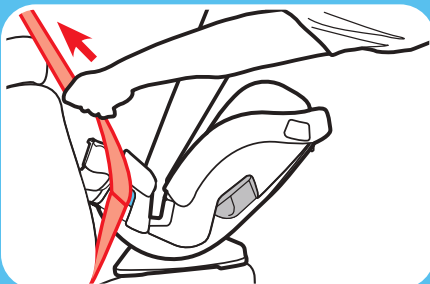
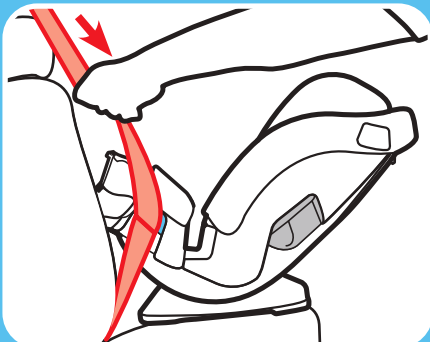
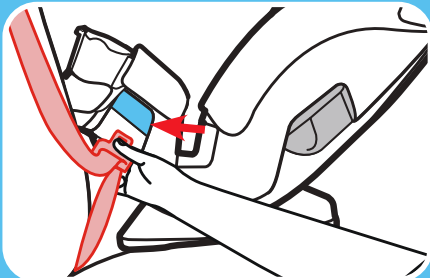

5. Route the Vehicle Seat Belt

Thread vehicle seat belt through the rear-facing belt path (marked with a blue label) and buckle it. The seat belt should lay as flat as possible and not be twisted.

Note: It may be easier to route the vehicle seat belt by lifting seat pad up to expose the belt path.

Make sure vehicle seat belt is in front of the buckle strap.

6. Lock the Vehicle Seat Belt

In most vehicles today, slowly pull the shoulder belt all the way out and then let it go back in. You will hear a clicking sound. Slowly pull out on the belt and it should be locked. If not, review your car's owner manual and section 9-F.

7. Tighten the Vehicle Seat Belt

Press down firmly in the center of the car seat. Pull on the shoulder belt to tighten while feeding the slack back in the retractor.



3 Rear Facing

8. Test For Tightness

Grab the sides of the seat where the vehicle seat belt is and slide the car seat side to side and front to back.

If the seat moves less than 1" (2.5 cm), it is tight enough.

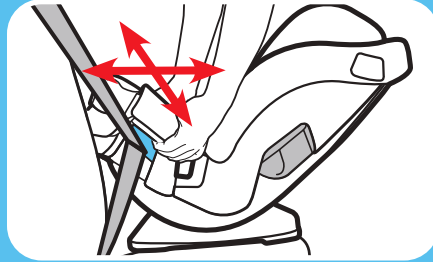

9. Check the Level Indicator

Vehicle **MUST** be on level ground. **Ball must be completely in the blue zone.** Readjust the incline if needed. Or if needed, rolled towels may be placed under the car seat at the vehicle seat crease, until the ball is completely in the blue zone.

See section 6-A to secure your child.

Recheck the level indicator with child in seat.

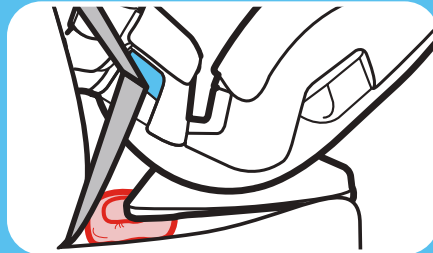
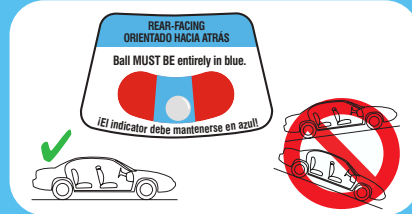

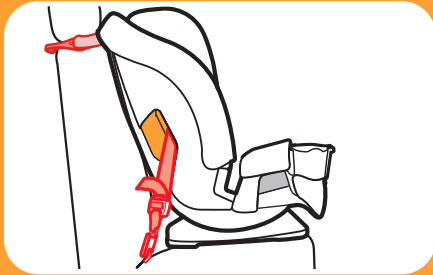

3 Rear Facing

4-A Forward-Facing Use

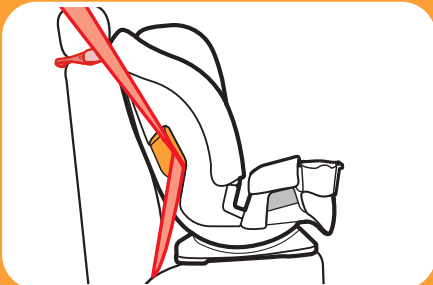

LATCH

Do not install by this method for a child weighing more than 45 lb (20 kg)



Vehicle Lap/Shoulder Seat Belt with Tether



Vehicle Lap Only Seat Belt with Tether

**Forward-Facing:
22-65 lb (10-30 kg) and
49" (125 cm) or less**

- Car seat must be forward-facing in the vehicle back seat.
- Make sure lower anchor strap or vehicle seat belt is routed through the forward-facing belt path marked with a orange label.
- Install this car seat tightly in your vehicle. Car seat **should not move** at the forward-facing belt path more than 1" (2.5 cm) from side to side and front to back.
- Attach and tighten tether strap.
- Harness straps must be **at or just above** the top of child's shoulders and chest clip must be at **armpit level**.
- Children are safer riding rear-facing and should ride rear-facing as long as possible, until they reach the maximum rear-facing height or weight rating for their car seat. Then children should ride forward-facing, using the built-in harness system for as long as possible until they reach the maximum forward-facing weight or height for their car seat. At that point, children should ride in a belt-positioning booster seat. Be sure to check your local and state laws, as well as AAP and NHTSA recommendations, for car seat usage.

4-B Install Forward-Facing With LATCH

Review your vehicle's owner manual for LATCH location and use.

1. Make Sure Lower Anchor Strap is in the Forward-Facing Belt Path Marked with Orange Label

If it is not, see section 7-A.

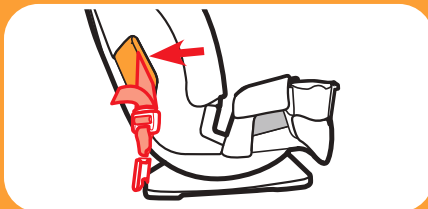

2. Recline the Car Seat

Place the car seat in recline position 3 or 4.

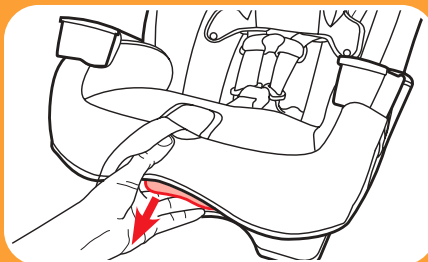
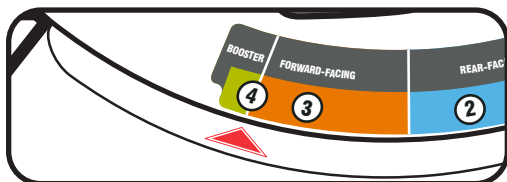

3. Remove Lower Anchor Connectors and Tether from Storage Locations

Push in on the red buttons on the lower anchor connectors and remove from storage position. Unhook tether and lay it in the seat.

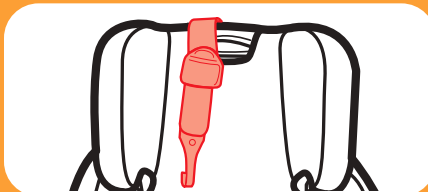
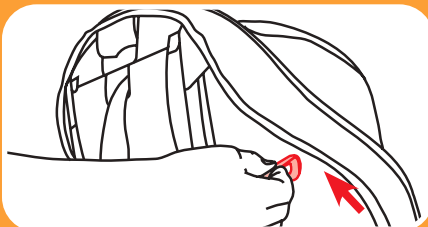
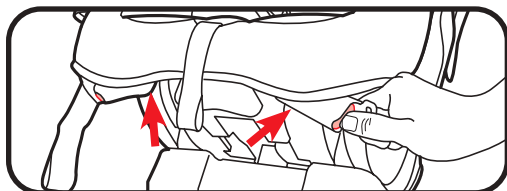

4 Forward Facing

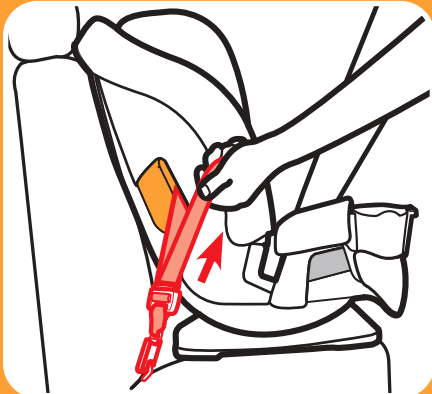
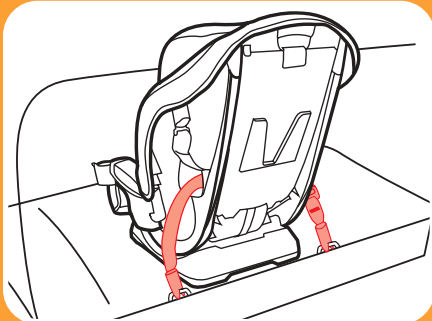
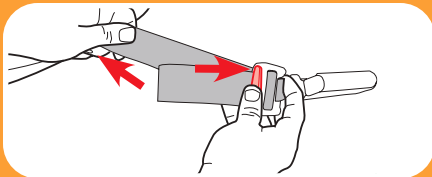

4. **Extend the Lower Anchor Strap**

For easier installation, extend the lower anchor strap to its maximum length by pressing the gray button and pulling out on the strap.

5. **Place Car Seat Forward-Facing in Back Seat of the Vehicle**

Place the base flat on the vehicle seat. Push it back firmly until the back of the car seat touches the vehicle seat back. Center the car seat between the lower anchors.

Make sure base is a minimum of 80% on the vehicle seat.

6. **Attach Lower Anchor Connectors to Vehicle's Lower Anchors**

Lower anchor strap should lay as flat as possible and not be twisted.

Lower anchor attachment can **ONLY** be used if the vehicle lower anchor spacing is 11 inches (28 cm) from the center of one lower anchor to the center of the other lower anchor.

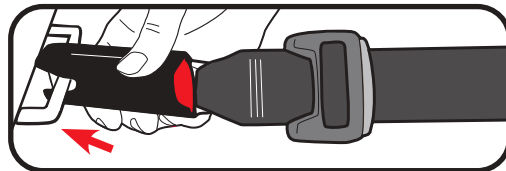

7. **Tighten the Lower Anchor Strap**

Press down firmly in the center of the car seat while tightening the lower anchor strap.

Note: You may need to tighten through the slit in the pad at the belt path as shown.

8. Attach Tether Strap

Extend the tether by lifting up on the tether lock and attach.

Consult vehicle's owner manual for specific location.

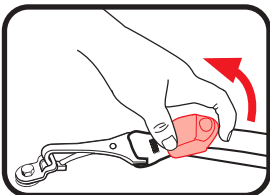

9. Tighten Tether Strap

Remove all the slack.

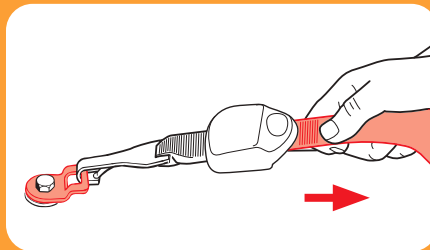
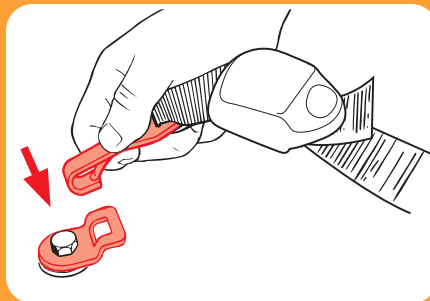
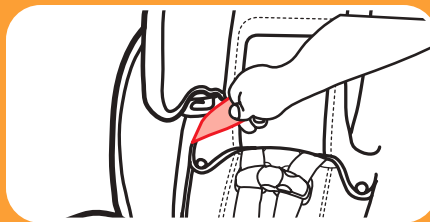

10. Test For Tightness

Grab the sides of the seat where the lower anchor strap is and slide the car seat side to side and front to back.

If the seat moves less than 1" (2.5 cm), it is tight enough.

See section 6-A to secure your child.

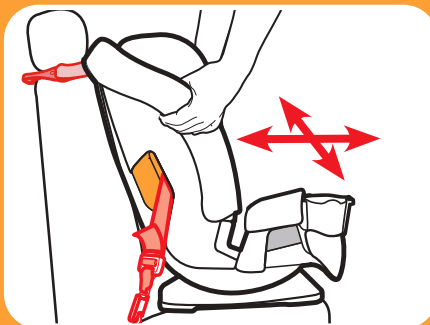

4 Forward Facing

4-C Install Forward-Facing With Vehicle Seat Belt

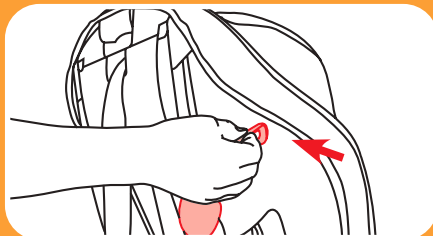
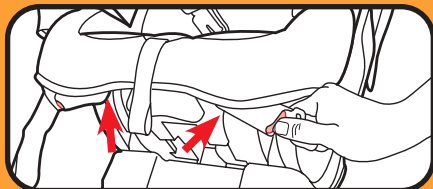
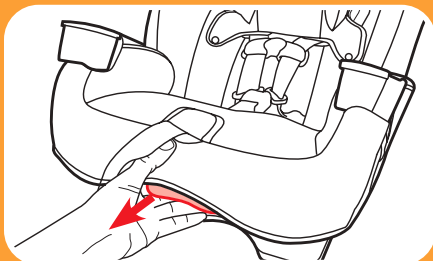

1. Recline the Car Seat

Place the car seat in recline position 3 or 4.

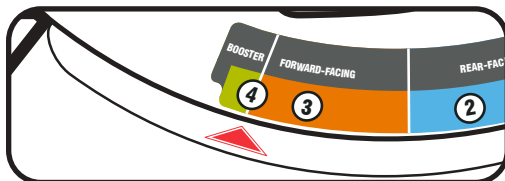

2. Store Lower Anchor Connectors

Attach the lower anchor connectors to plastic bar as shown and remove the slack from the strap.

3. Place Car Seat Forward-Facing in Back Seat of the Vehicle

Place the base flat on the vehicle seat. Push it back firmly until the back of the car seat touches the vehicle seat back.

4. Unhook Tether Strap From Storage Location and Lay it in the Seat

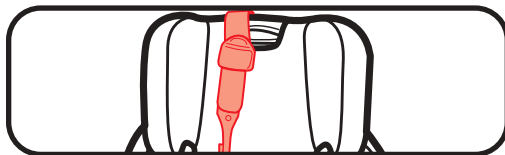

Review your vehicle's owner manual for vehicle seat belt use

5. Route the Vehicle Seat Belt

Thread vehicle seat belt through the forward-facing belt path (marked with an orange label) and buckle it. The seat belt should lay as flat as possible and not be twisted.

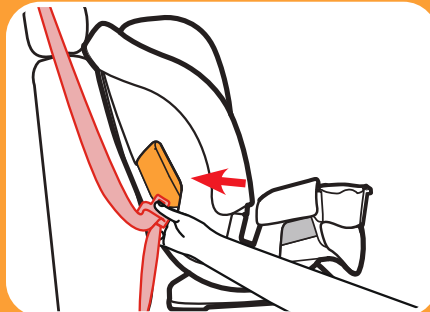

6. Lock the Vehicle Seat Belt

In most vehicles today, slowly pull the shoulder belt all the way out and then let it go back in. You will hear a clicking sound. Slowly pull out on the belt and it should be locked. If not, review your car's owner manual and section 9-F.

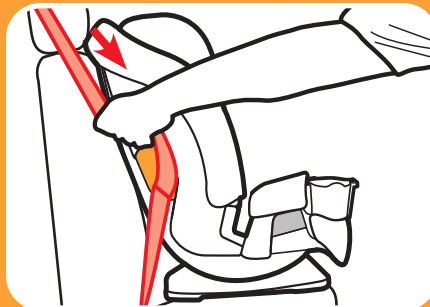

7. Tighten the Vehicle Seat Belt

Press down firmly in the center of the car seat. Pull on the shoulder belt to tighten while feeding the slack back in the retractor.



8. Attach Tether Strap

Extend the top tether by lifting up on the tether lock and attach.

Consult vehicle's owner manual for specific location.

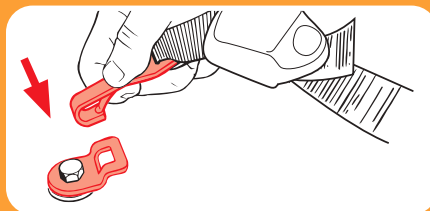
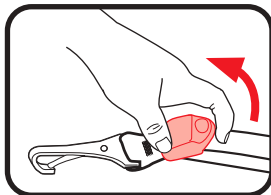

4 Forward Facing

9. **Tighten Tether Strap**

Remove all the slack.

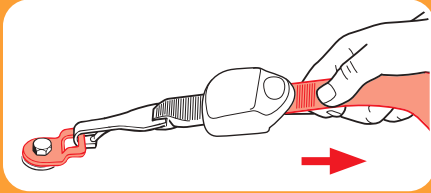

10. **Test For Tightness**

Grab the sides of the seat where the forward-facing belt path is and slide the car seat side to side and front to back.

If the seat moves less than 1" (2.5 cm), it is tight enough.

See section 6-A to secure your child.

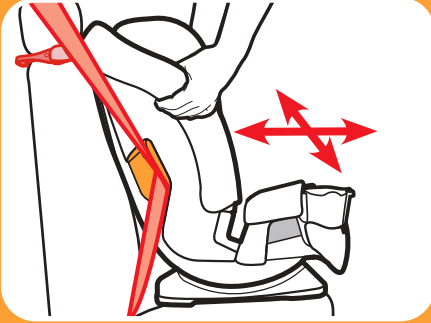

4 Forward
Facing

5-A Booster Use

Booster Use:

40-100 lb (18.1-45 kg)

43-57" (110.1-145 cm)

At least 4 years old

- Car seat must be forward-facing in the vehicle back seat.
- Vehicle seat belts **MUST** lay flat against child and **MUST NOT** be twisted.
- Make sure vehicle seat's lap belt is adjusted snugly, lays low on the child's hip, and is routed behind the armrest in the booster's belt path marked with a green label.
- Make sure vehicle seat's shoulder belt is centered between the child's neck and edge of shoulder.
- **Never** use a vehicle lap only seat belt across front of child.
- **DO NOT** position vehicle shoulder belt under the child's arm or back.
- **DO NOT** allow child to slouch or slide down in the booster seat.
- **DO NOT** position vehicle seat belt over top of armrests.
- Vehicle seat's headrest **SHOULD NOT** create a gap between vehicle seat and booster seat.
- The front of booster seat base **MUST NOT** hang over front of vehicle seat.
- If child will not keep the vehicle seat belt properly positioned, **DO NOT** use this booster seat. Use a different car seat.
- When forward-facing, children should use the built-in harness system for as long as possible until they reach the maximum forward-facing weight or height for their car seat. At that point, children should ride in a belt-positioning booster seat. A booster is no longer needed once the vehicle seat belt fits properly, typically when they reach 4 feet 9 inches (145 cm) tall and are between ages 8-12. Be sure to check your local and state laws, as well as AAP and NHTSA recommendations, for car seat usage.



Vehicle Lap/Shoulder Seat Belt



Never use a vehicle lap only seat belt across front of child.



5 Booster

5-B Install Highback Booster

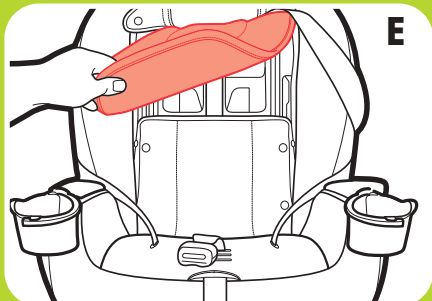
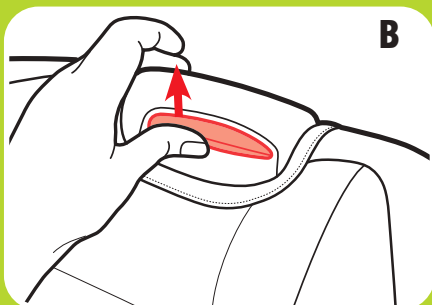
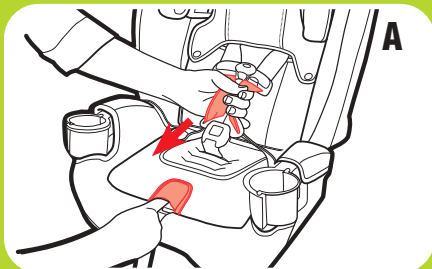

1. Store the Harness

Push down on the harness release lever while pulling out on the harness straps at the chest clip. (A)

Raise the headrest to the highest position. (B)

Unbuckle the chest clip and the buckle. (C and D)

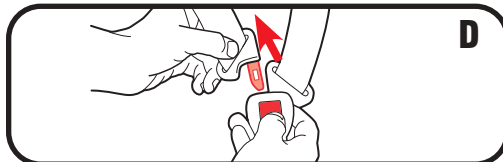
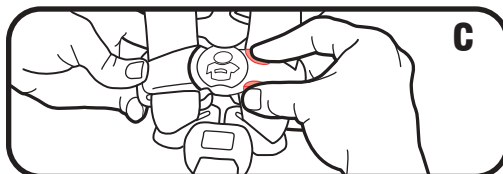

Remove the Lower Seat Pad to Expose the Harness Storage Door (E, F and G)

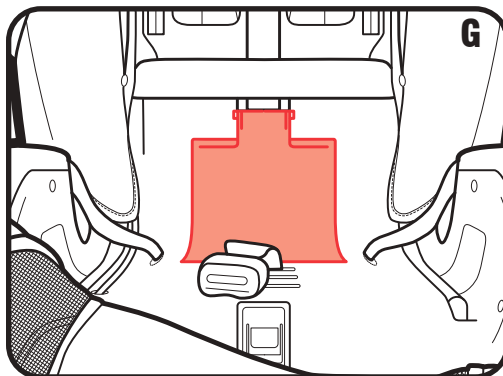

Move Buckle Strap to Rear Slot

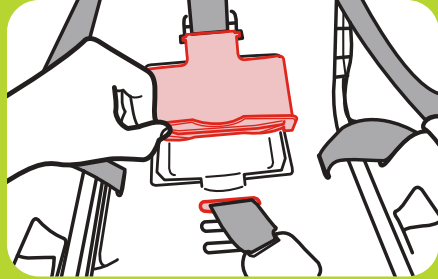

Open the Harness Storage Door and Place Harness, Chest Clip, Buckle, and Buckle Tongues Inside Storage Compartment. Close the Door

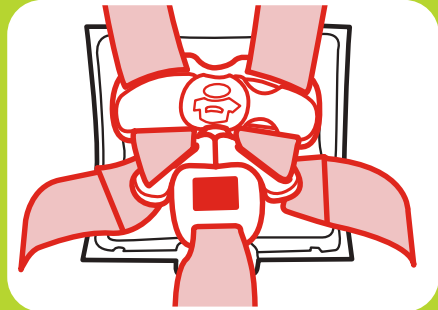

Replace Seat Pad

Move the headrest back to its proper position for your child.

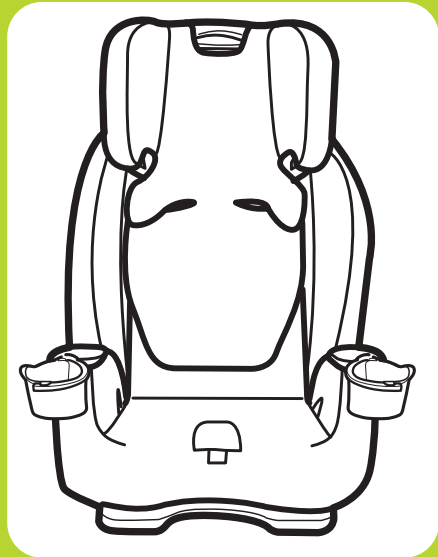

5 Booster

2. Recline the Car Seat

Place the booster seat in recline position 4.

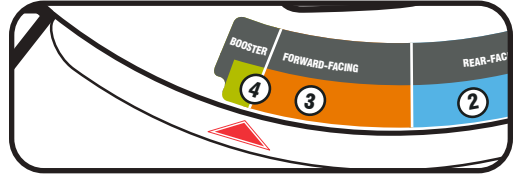
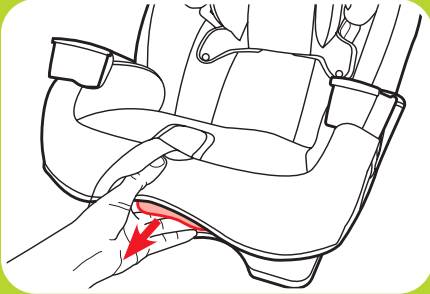

Graco allows the securing of the car seat with LATCH in the booster mode. The child still **MUST BE SECURED** with the vehicle lap/shoulder seat belt. LATCH can be used in the booster mode regardless of the weight of the child up to 100 lb (45 kg).

Verify the following before using LATCH in the booster mode:

- The lower anchor connector **DOES NOT** interfere with any vehicle seat belts or buckles.

If the lower anchor connector interferes with the vehicle seat belts or if the chosen seating position does not have lower anchors, you **MUST** store the lower anchor strap. Always secure car seat with lower anchor strap or a vehicle seat belt, even when unoccupied. In a crash, an unsecured car seat can injure passengers. Store the tether strap as shown.

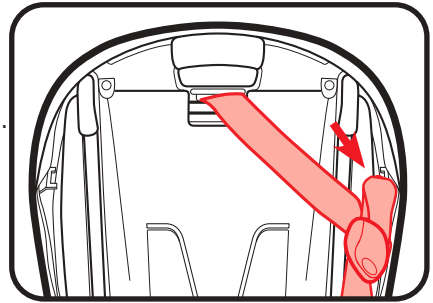
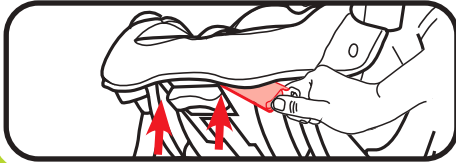

3. Place the Booster Seat Forward-Facing in the Back Seat of Vehicle

Place forward-facing on a vehicle seat that has a lap/shoulder seat belt. The base should sit as flat as possible on the vehicle seat.



4. Make Sure Lower Anchor Strap is in the Forward-Facing Belt Path, Marked with Orange Label

If it is not, see section 7-A.

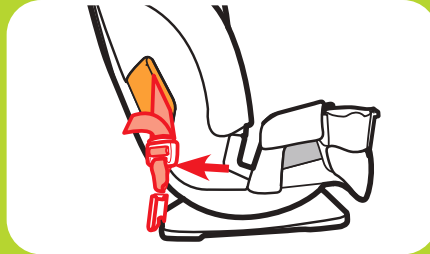

5. Unhook Tether Strap From Storage Location and Lay it in the Seat

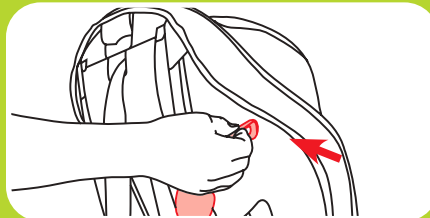
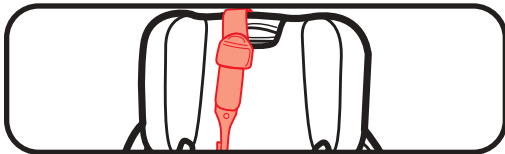

6. Connect Lower Anchor Connectors to Vehicle's Lower Anchors

Lower anchor strap should not be twisted.

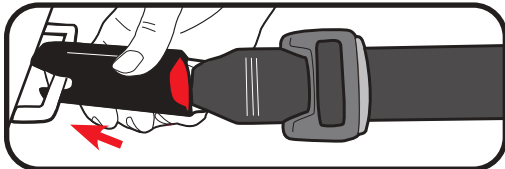
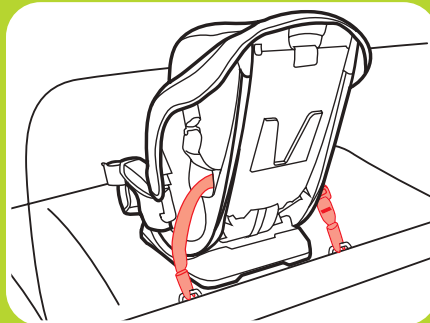

7. Tighten the Lower Anchor Strap

Remove all the slack.

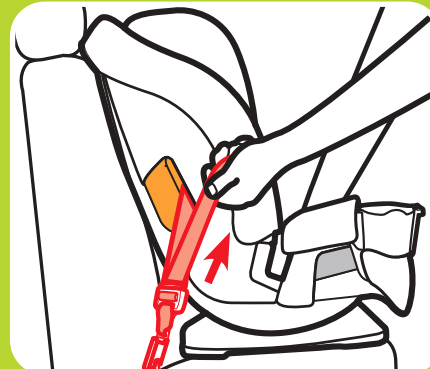

5 Booster

8. Attach Tether Strap

Extend the tether by lifting up on the tether lock and attach.

Consult vehicle's owner manual for specific location.

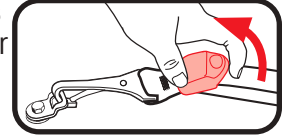

9. Tighten Tether Strap

Remove all the slack.

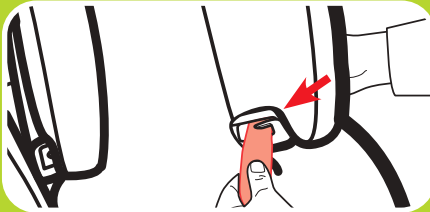
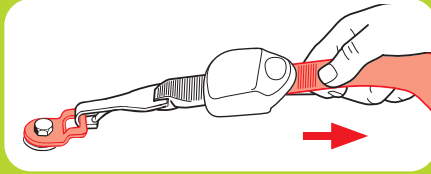

10. Thread the Vehicle Shoulder Belt Through Shoulder Belt Guide on the Headrest

See section 6-B to secure your child.



6-A Securing Child 5-point Harness



1. Loosen Harness Straps

Push down on the harness release lever while pulling out on the harness straps at the chest clip. (A)

Unbuckle the chest clip (B) and the buckle (C). Place harness straps off to the sides.

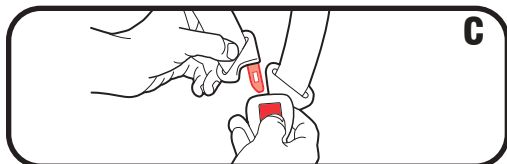
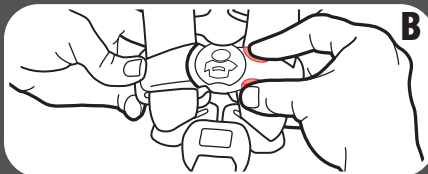
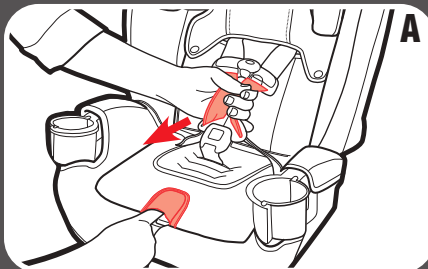

2. Place Your Child in the Seat

Make sure their back is flat against the car seat back.

Avoid bulky or heavy clothing when it is cold out. Doing so will prevent the harness straps from tightening properly. If needed, place a blanket over the child after you have secured them.

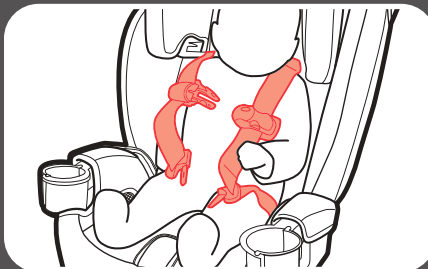

3. Place Harness Straps Over Child's Shoulders and Buckle

You will hear a "click" when buckle tongues are securely attached. Pull up on each buckle tongue to make sure it is securely attached.

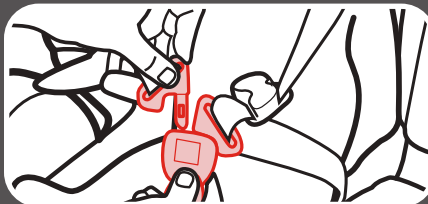



Rear-Facing



Forward-Facing

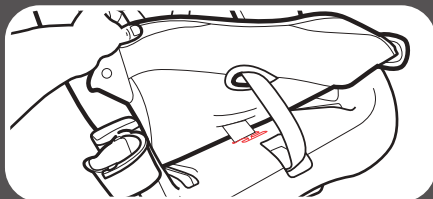
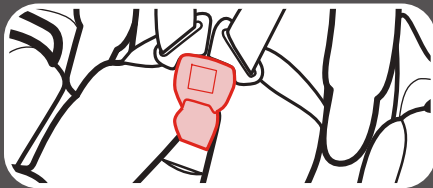
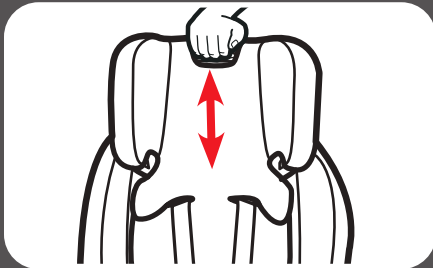

4. Be Sure the Harness Straps Are at the Proper Height

Rear-Facing: Harness straps must be **at or just below** the child's shoulders and top of head **must be at least 1" (2.5 cm) below** the red headrest/harness adjustment handle.

Forward-Facing: Harness straps must be **at or just above** the child's shoulders and top of child's ears must be **below** top of headrest.

To Raise or Lower Headrest/ Harness Height

Squeeze the red adjustment handle and move headrest for the proper harness height.

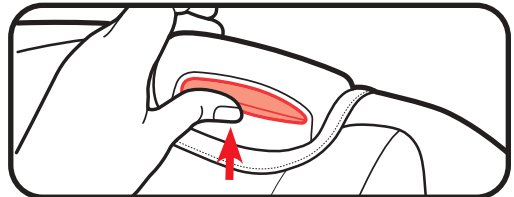

5. Check the Buckle Position

The correct slot is the one that is closest to your child without being underneath them.

To Adjust, Lift the Lower Seat Pad From Front of Car Seat to Expose The Buckle Slots

Turn Buckle Strap Sideways and Slide to Desired Slot

Make sure buckle strap is in one of the three positions.

Make Sure Lower Anchor Strap is in Front of Buckle Strap

6. Replace Seat Pad, Making Sure the Buckle Goes Through the Same Slot in the Seat Pad as in the Plastic Shell

7. Buckle the Chest Clip

You will hear a “click” when the chest clip is securely buckled.

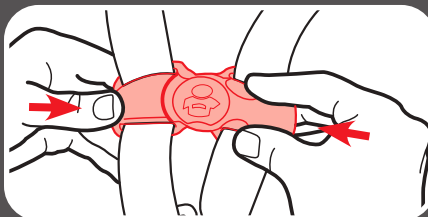
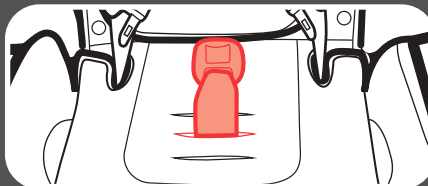
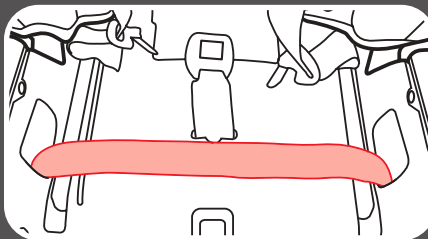
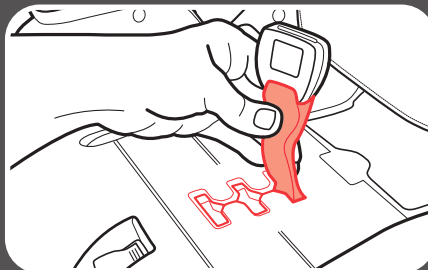
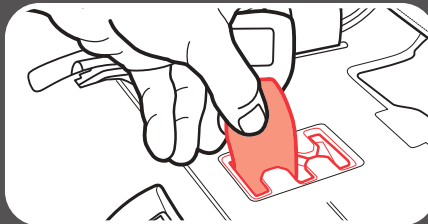

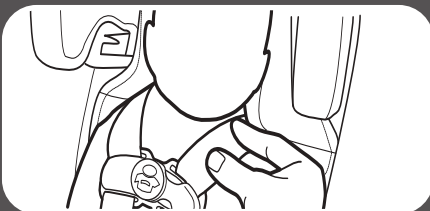
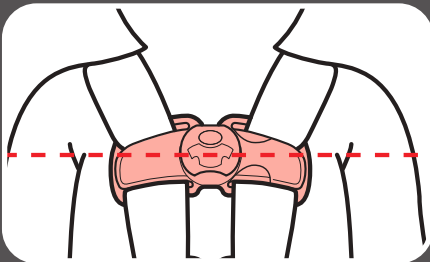
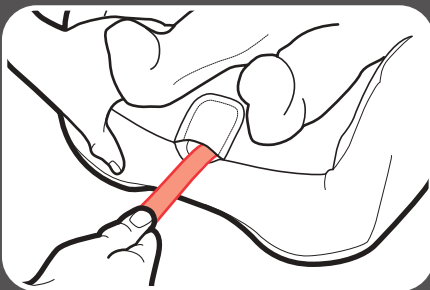
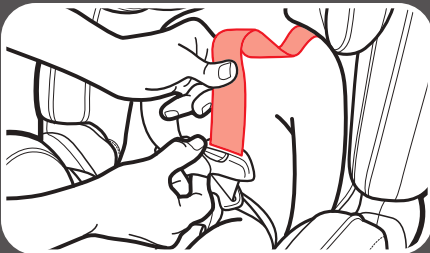

8. Pull All the Slack Out From Around the Waist

Pull up on the harness strap while pushing the chest clip down. Do this to both sides.

9. Tighten the Harness by Pulling the Harness Adjustment Strap

A snug harness should not allow any slack. It lies in a relatively straight line without sagging. It does not press on the child's flesh or push the child's body into an unnatural position.

When you are not able to pinch any of the harness webbing at your child's shoulder, the harness is tight enough.

10. Raise the Chest Clip to Child's Armpit Level

11. Check Tightness

Tighten more if needed.

6-B Securing Child Highback Booster



WARNING! Use only the vehicle lap and shoulder belt system when restraining the child in the booster seat.

1. Place Child In Seat

Have your child sit in the booster seat, with their back flat against the back of the booster seat.

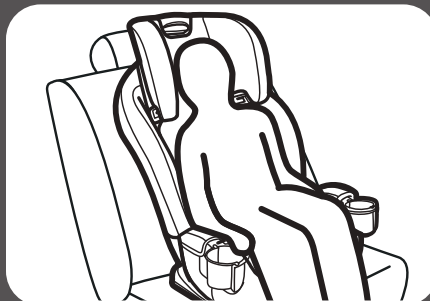

2. Thread Vehicle's Shoulder Belt Through Booster Shoulder Belt Guide in the Headrest

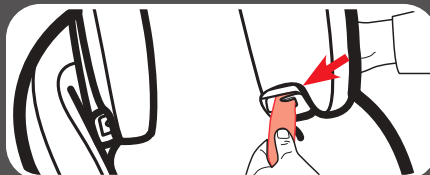

3. Buckle the Vehicle Lap/Shoulder Seat Belt

Be sure the lap portion of the vehicle seat belt goes behind the armrests. Both the lap and shoulder belt must lay in the booster belt path on the buckle side of the seat.

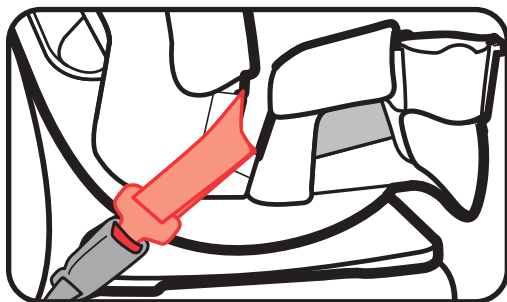
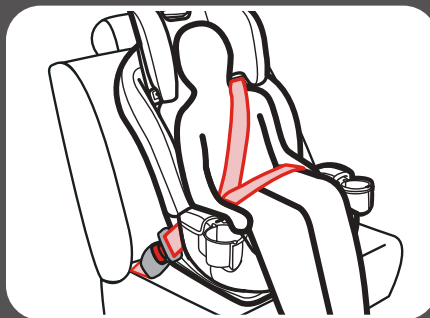



6 Securing
Child

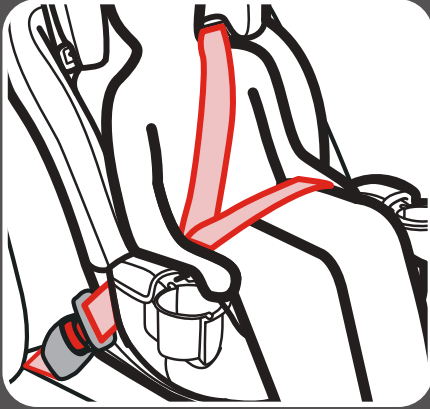

Be sure the lap portion of the vehicle seat belt is low across your child's hips.

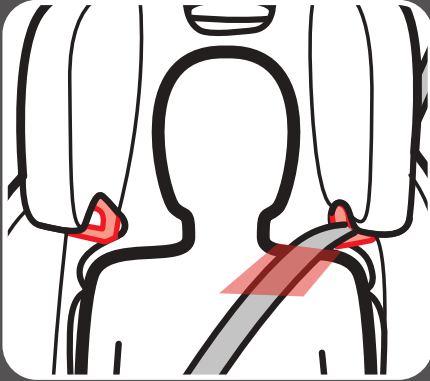

Vehicle seat's shoulder belt should be centered between the child's neck and edge of shoulder.

Raise or lower the headrest to change the shoulder belt location on the child.

7-A Moving Lower Anchor Attachment

1. For Ease of Moving the Lower Anchor Attachment

- A. Push down on the harness release lever while pulling out on the harness straps at the chest clip.
- B. Raise the headrest to the highest position.
- C. Unbuckle the chest clip.
- D. Unbuckle the buckle.

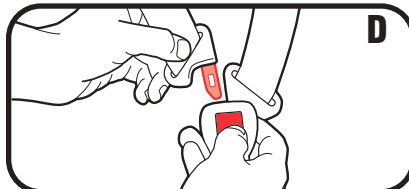
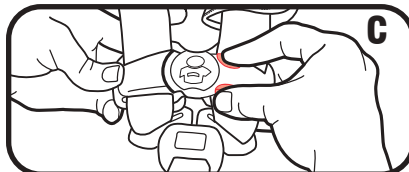
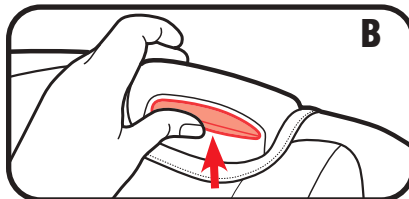
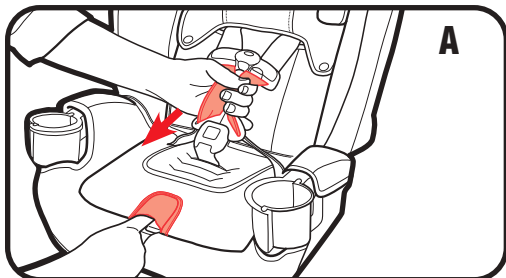

2. Remove the Lower Seat Pad to Expose the Lower Anchor Strap

Note the orange and blue labels at the top and bottom of the red bar (G).

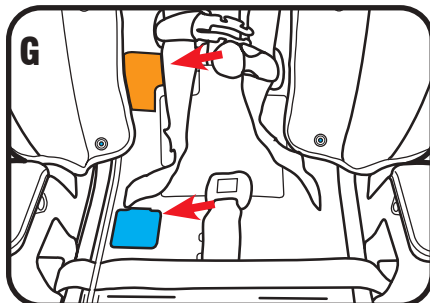
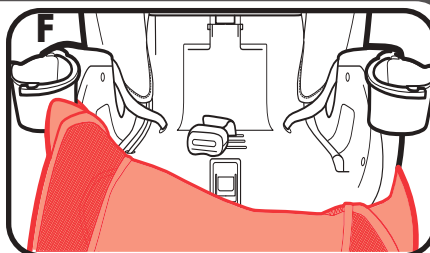
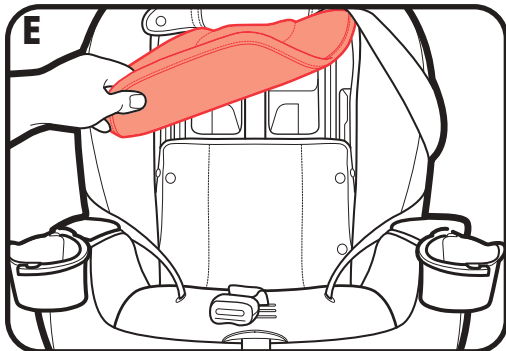

**7 Moving
Lower Anchor**

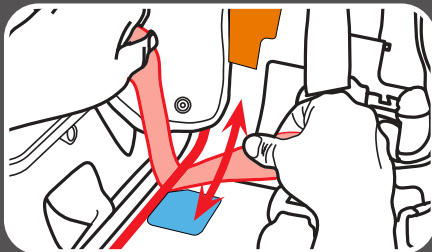
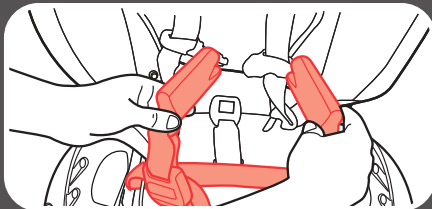

3. Pull Lower Anchor Connectors Out of the Belt Path Openings into the Center of the Car Seat

4. Slide Entire Lower Anchor Strap Along the Red Bar to the Desired Belt Path Openings

Rear-Facing: Slide lower anchor strap along bar to the front of the seat.

Forward-Facing: Slide the lower anchor strap up along bar to the top.

5. Push the Lower Anchor Connectors Out Through the Desired Belt Path Openings on Each Side of Car Seat

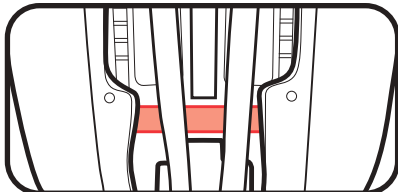
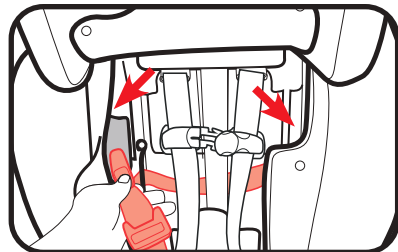

Forward-Facing: Make sure the lower anchor strap is routed behind the harness strap, is flat, and is not twisted.

OR

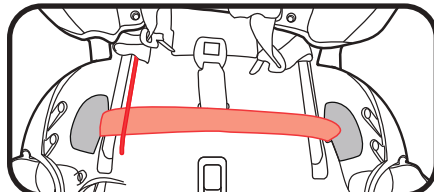
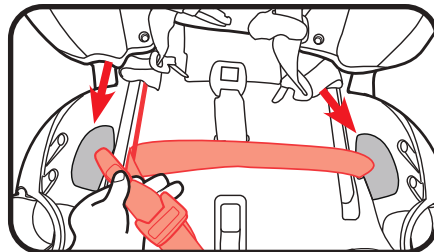

Rear-Facing: Make sure the lower anchor strap is in front of the buckle strap, is flat, and is not twisted.

6. Replace Seat Pad

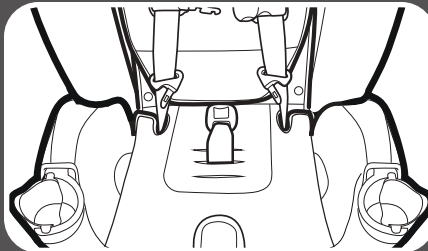

7. Move the Headrest to Its Proper Position for Your Child

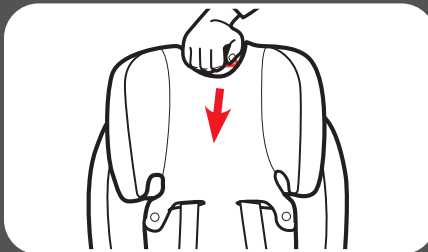

**7 Moving
Lower Anchor**

8-A Accessories *(on select models)*

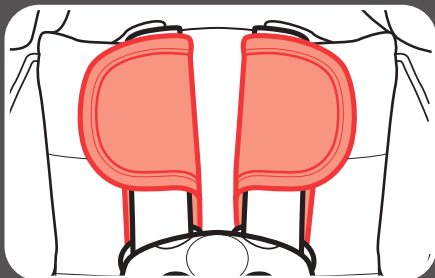

Harness Covers

Make sure that harness covers do not interfere with placement of the chest clip at armpit level.

To remove, undo the fastening strips and remove.

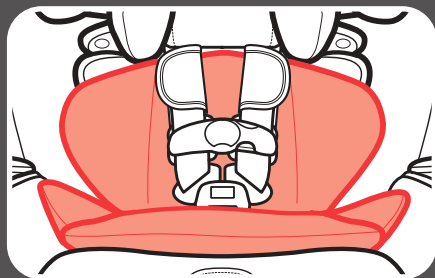

Body Support

Use only in the rear-facing mode.

Body support must be used if shoulders are below the lowest harness setting.

Never allow body support to bunch or fold behind child.

To remove, unbuckle the buckle and pull out the body support.

Headrest Pillow

To remove, pull the pillow out.

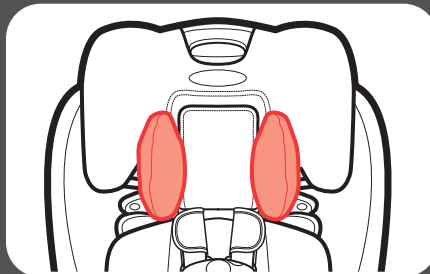

Cup Holder

To use cup holder, lift the inside cup (A) and rotate until it locks into place (B).

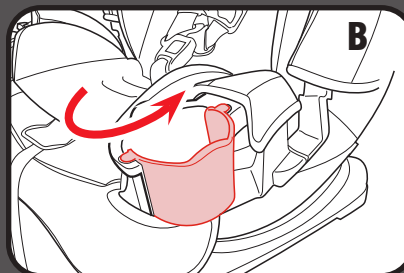
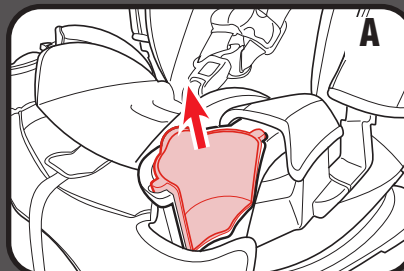

9-A How to Uninstall Lower Anchor Connectors and Tether



Lower Anchor Connectors

To remove the lower anchor connectors from the lower anchors, push in on the red buttons and pull them off.

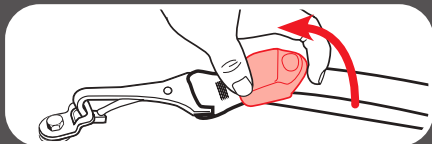

Tether

To remove, lift up on the tether lock to release the tension.

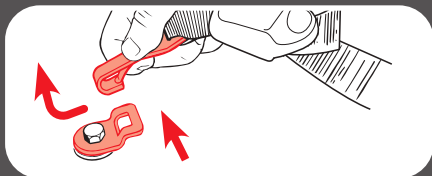

Press in on the hook's spring. Push tether hook in, then lift up and pull away from tether anchor.

9-B Choosing Vehicle Seat Location

Review your vehicle owner's manual for seating locations.

The best seating location for this car seat is one that:

- Is recommended by your vehicle owner's manual, and
- Results in a secure installation of this car seat.

In the event there is no available back seat and / or you have no other option than to place a child other than an infant in a rear-facing car seat in a front passenger seating position, the National Highway Traffic Safety Administration (NHTSA) recommends that you take the following steps:

- Ensure the child is properly restrained according to their age and size.
- Move the seat as far back as possible.
- Make sure the child is not leaning out of position, such as leaning forward into the deployment path of the air bag.
- Set the air bag ON-OFF switch, if available, to the OFF position.

9-C Unsafe Vehicle Seat Locations

Never install this car seat in any of the following vehicle seating locations:



rear-facing or side-facing
vehicle seats



rear-facing with an
active front air bag



booster mode with vehicle lap
only seat belt

9-D Vehicle Seat Belts

Review your vehicle owner's manual for vehicle seat belt use

This car seat can be installed using a vehicle seat belt. To do this, you will need to change the seat belt to a locked mode for use with car seats. With some vehicle seat belts, this is done with the latchplate; with other vehicle seat belts, this is done with the retractor.

Vehicle Seat Belt Terms

Retractor

A device that winds up the unused vehicle seat belt. It is often hidden inside the panels on the walls of the vehicle or in the vehicle seat back.

Latch Plate

The male end of the seat belt with the silver tongue.

Seat Crease

The crease where the vehicle seat back and seat bottom meet.

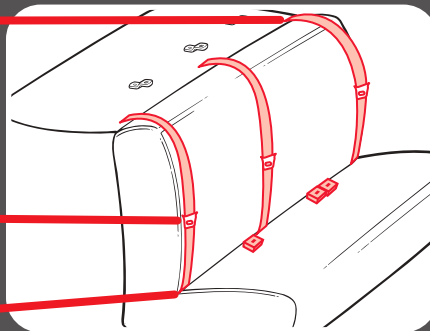

Identify Your Seat Belt Type

There are two different types of vehicle seat belts that can be used with this car seat:

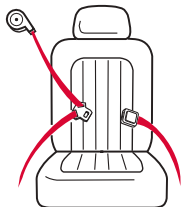

Lap/Shoulder Seat Belt

3 connection points. Can be used in all car seats modes of use.

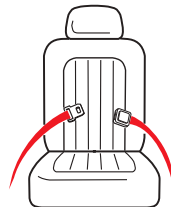

Lap Only Seat Belt

2 connection points. **Can ONLY be used in harness mode.**

The following types of vehicle seat belts **CANNOT** be used safely with this car seat:



Lap Belt with Motorized Shoulder Belt



Lap Belt or Shoulder Belt Mounted on Door

Belts Forward of the Seat Bight

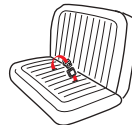

Some vehicles you may not get a secure fit. Read both your vehicle and car seat manuals.

Lap/Shoulder Seat Belt Installation - Harness Mode

Always review your vehicle owner's manual for specific information about your vehicle seat belts.

There are three types of retractors: **ELR (Emergency Locking Retractor)**, **ALR (Automatic Locking Retractor)**, and **Switchable (ELR switch to ALR)**. To determine your type of retractor, follow these steps:

1. **Slowly** pull the belt out about halfway and stop.
2. Let the belt retract back several inches.
3. Try to **slowly** pull the belt out more. If the belt cannot be pulled any further, it is **ALR**. If it can be pulled further, go to the next step.
4. **Slowly** pull the belt all the way out, and then allow it to retract several inches.
5. Try to pull the belt all the way out again. If it cannot be pulled out, it is **Switchable**. If it can still be pulled out freely, it is **ELR**.

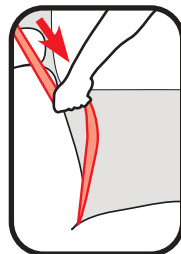

Note: Most vehicles manufactured after 1996 will have Switchable retractors in the back seat. If you have any questions about your retractor type, consult your vehicle owner's manual or call Graco for assistance.

How to Lock Your Lap/Shoulder Vehicle Seat Belt

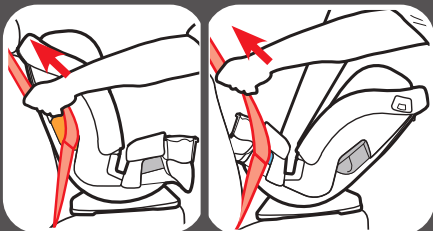
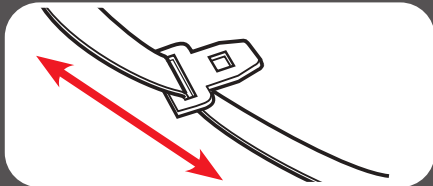

Note: With the vehicle seat belt in this locking mode, all the tension is upwards in the shoulder belt. This may start to tilt your car seat sideways. If this happens, use a locking clip instead of switching the retractor. See Sliding Latch Plate and ELR Retractor.

Sliding Latch Plate and Switchable Retractor

A latchplate that slides freely on the belt webbing and cannot, by itself, hold the belt snug around a car seat.

When installing the car seat, route the vehicle seat belt through the proper belt path and buckle it in. **Slowly pull the shoulder belt all the way out to switch it to locking mode.** Then, as you pull the vehicle seat belt tight, feed all the slack back into the retractor.

Grab the sides of the seat at the belt path and slide the seat side to side and front to back. The seat should not move more than 1" (2.5 cm).

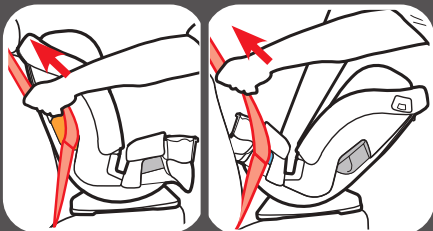
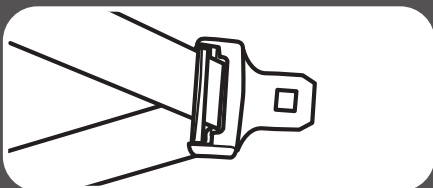

Locking Latchplate and ELR Retractor

A latchplate that holds the lap belt snug after it has been adjusted; contains a metal bar on the underside of the hardware that "locks" the belt in position.

When installing the car seat, route the vehicle seat belt through the proper belt path and buckle it in. Then, pull upwards on the shoulder belt so that the lap belt gets tight around the car seat.

Grab the sides of the seat at the belt path and slide the seat side to side and front to back. The seat should not move more than 1" (2.5 cm).

Sliding Latch Plate and ALR Retractor

A latchplate that slides freely on the belt webbing and cannot, by itself, hold the belt snug around a car seat.

Slowly pull the shoulder belt all the way out. Route the vehicle seat belt through the proper belt path and buckle it in. Then, as you pull the vehicle seat belt tight, feed all the slack back into the retractor.

Grab the sides of the seat at the belt path and slide the seat side-to-side and front-to-back. The seat should not move more than 1" (2.5 cm).

Sliding Latch Plate and ELR Retractor

A latchplate that slides freely on the belt webbing and cannot, by itself, hold the belt snug around a car seat.

With this retractor, you will need to use the locking clip to lock the vehicle seat belt.

Call us at 1-800-345-4109 to order a locking clip.

Route the vehicle seat belt through the proper belt path and buckle it in. Pull the vehicle seat belt tight. While pushing down on seat, pinch the two straps together behind the buckle tongue. Unbuckle the belt without allowing it to slip.

Attach locking clip to lap and shoulder belts as shown.

Rebuckle belt. Check that lap belt does not move by pulling hard. If belt loosens or lengthens, repeat procedure.

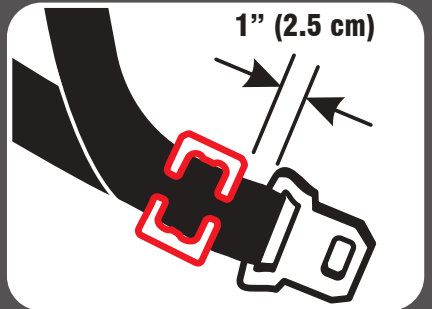
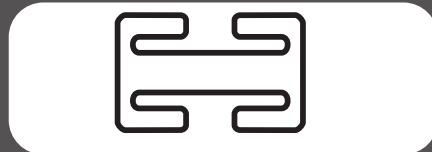
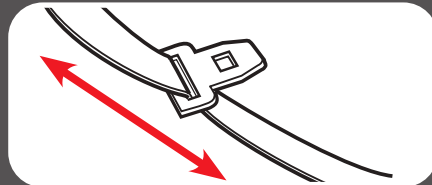
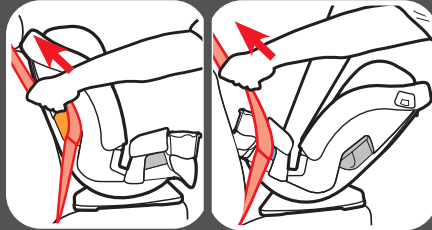
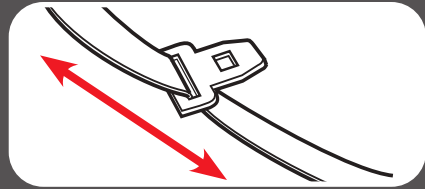

Lap Belt Installation - DO NOT use in Booster Mode

Always review your vehicle owner's manual for specific information about your vehicle seat belts.



Grab the sides of the seat at the belt path and slide the seat side to side and front to back. The seat should not move more than 1" (2.5 cm).

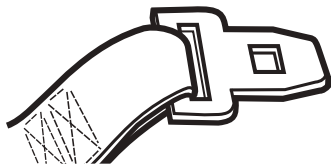

Locking Latch Plate and No Retractor

When installing the car seat, route the lap seat belt through the proper path and buckle it in. Then, pull upwards on the tail of the belt so that the lap belt gets tight around the car seat.

Sewn On Latch Plate and ALR Retractor

Slowly pull the lap belt all the way out. Route the vehicle seat lap belt through the proper belt path and buckle it in. Then, pull the lap belt tight while feeding all the slack back into the retractor.

10-A Cleaning Seat Pad

Clean with a damp sponge using mild soap and cool water. Refer to seat pad care tag for washing instructions.

Headrest Pad

If needed, headrest pad may be removed for cleaning.

To remove, unsnap the pad to pull the harness straps out.

Pull the plastic tab out of the slots just below the red adjustment handle.

Remove the elastic straps from the hooks on both sides of the headrest.

Pull pad off of headrest.

Machine wash cover in cold water on delicate cycle and drip-dry. **DO NOT USE BLEACH.**

Reverse the steps to reattach the cover on the headrest.

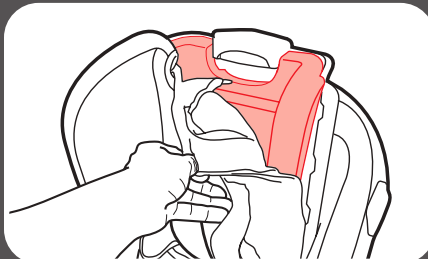
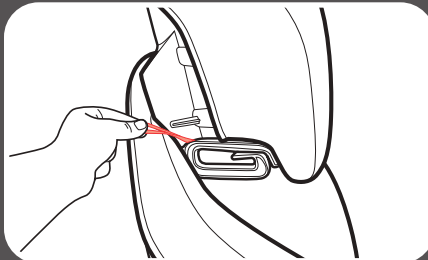
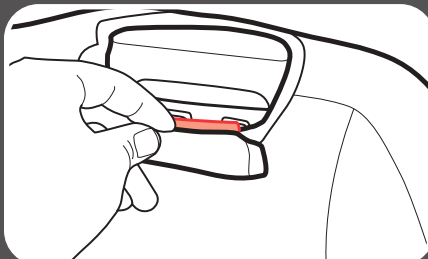
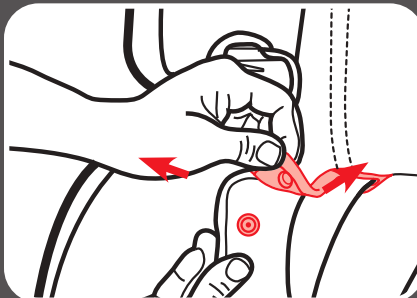

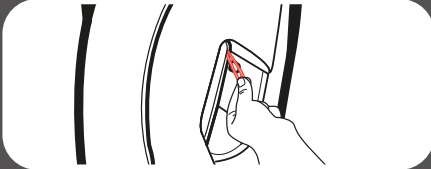
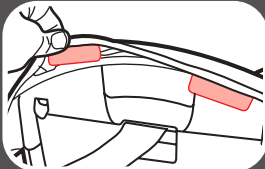
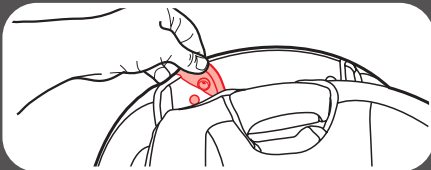
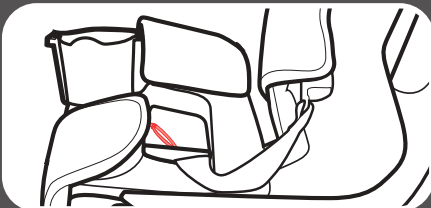
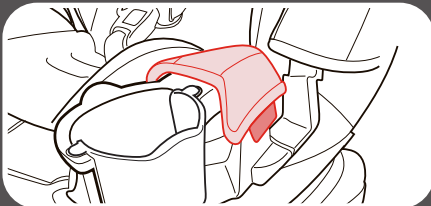
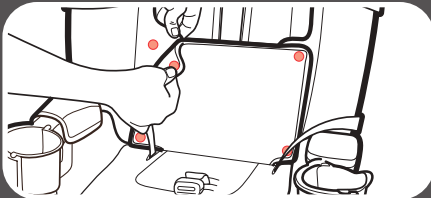

Lower Seat Pad

If needed, lower seat pad may be removed for cleaning.

To remove, unsnap lower seat pad from side pad.

Undo the plastic tabs on both armrests.

Remove the elastic straps from the hooks in the rear-facing belt path.

Pull the pad off.

Machine wash cover in cold water on delicate cycle and drip-dry. **DO NOT USE BLEACH.**

Reverse the steps to reattach the bottom seat pad. Place front of the plastic shell in the pocket in the pad.

Side Pad

If needed, side pad may be removed for cleaning.

To remove, lower headrest and unsnap the pad from back.

Pull the plastic tabs out from the back and sides of the seat.

Remove the elastic straps from the hooks in the forward-facing belt path.

Pull the pad off.

Machine wash cover in cold water on delicate cycle and drip-dry. **DO NOT USE BLEACH.**

Reverse the steps to reattach the bottom seat pad. Place the corner of the sidewing in the pocket at the bottom of the side pad.

10-B Cleaning Crotch Buckle

Recline the car seat and locate the metal retainer. Rotate the metal retainer up through the shell and pad. From the front, pull out the buckle.

To clean buckle, place in a cup of warm water and gently agitate the buckle. Press the red button several times while in the water.

DO NOT SUBMERGE THE BUCKLE STRAP. DO NOT USE SOAPS, HOUSEHOLD DETERGENTS or LUBRICANTS.

Shake out excess water and allow to air dry. Repeat steps as needed until it fastens with a click. Re-insert the buckle into the same slot it was removed. Pull up on buckle to make sure it is secured.

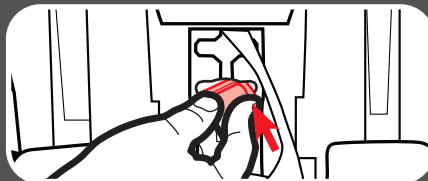

WARNING! Inspect and clean buckle from time to time to remove any objects or debris that could prevent latching.

10-C Cleaning Harness, Lower Anchor and Tether Straps

Surface wash only with mild soap and damp cloth. **DO NOT IMMERSE THE HARNESS STRAPS or LOWER ANCHOR STRAP or TETHER STRAP IN WATER.** Doing so may weaken the straps. If harness straps or lower anchor belt or tether strap are frayed or heavily soiled, contact Customer Service at www.gracobaby.com or 1-800-345-4109.

NOTES:

NOTES:

Replacement Parts

To purchase parts or accessories in the United States,
please contact us at the following:

www.gracobaby.com

or

1-800-345-4109

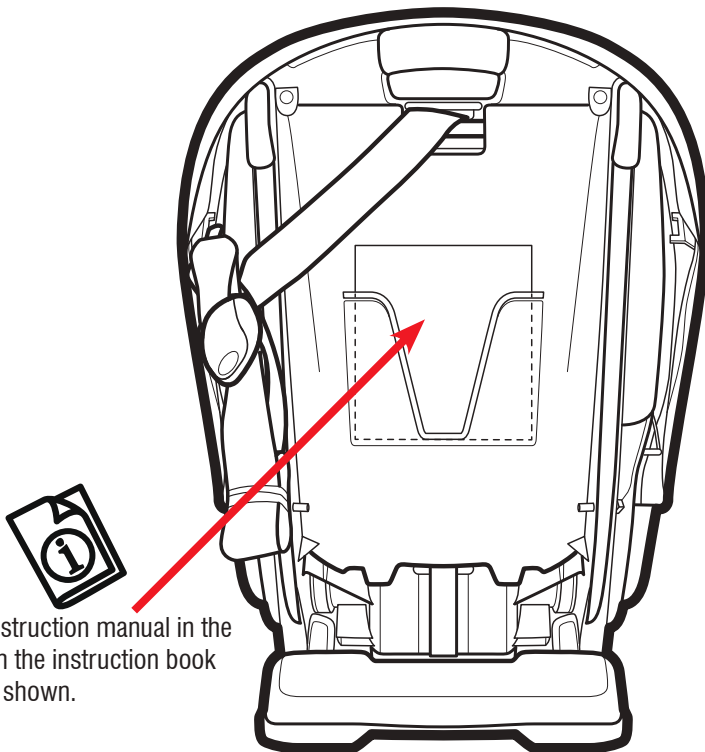

Store instruction manual in the
slot with the instruction book
icon as shown.